

Thank you for purchasing our product.  
Please read this User's Manual before  
using the product. Change without Notice

## 4 Channel Digital Video Recorder

# User's Manual



## Safety Precautions

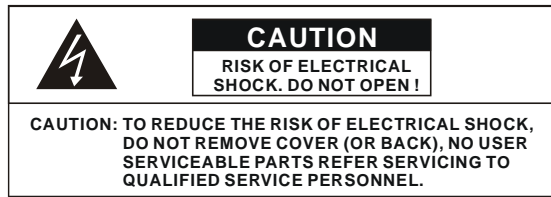

This label may appear on the bottom of the unit due to space limitations.



The lightning flash with arrowhead symbol, within an equilateral triangle, is intended to alert the user to the presence of insulated dangerous Voltage within the product's enclosure that may be sufficient magnitude to constitute risk of electrical shock to persons.



The exclamation point within an equilateral triangle is intended to alert the user to the presence of important operation and maintenance (servicing) instructions in the literature accompanying the appliance.

**WARNING: TO PREVENT FIRE OR SHOCK HAZARD, DO NOT EXPOSE UNITS NOT SPECIFICALLY DESIGNED FOR**



Attention: installation should be performed by qualified service Personnel only in accordance with the National Electrical Code or applicable local codes.



Power Disconnect. Units with or without ON-OFF switches have power supplied to the unit whenever the power cord is inserted into the power source; however, the unit is operational only when the ON-OFF switch is the ON position. The power cord is the main power disconnect for all unites.



“CAUTION: Danger of explosion if battery is incorrectly replaced. Replace only with the same or equivalent type recommended by the manufacturer. Dispose of used batteries according to the manufacturer's instruction.”

Warranty  
and Service

During the warranty period (one year), we will repair or replace the DVR free of charge.

Be sure to have the model number, serial number and vendor stick on hard disk for service representative.

## About this document

Before installing stand alone DVR, be sure to thoroughly review and follow the instructions in this Users Manual. Pay particular attention to the parts that are marked **NOTICE**.

Also, when connecting with external application, first turn the power OFF and follow manual instruction for appropriate installation.

## Before reading this document

1. This document is intended for both the administrator and users of stand alone DVR Model.
2. This manual contains information for configuring, managing and using stand alone DVR Model.
3. To prevent fire or electrical shock, do not expose the product to heat or moisture
4. Be sure to read this manual before using stand alone DVR Model.
5. For questions and technical assistance of this product, contact your local dealer.

► Strong recommendation on installation of the DVR unit

1. Check electricity at the place you want to install the DVR unit is stable and meets our electricity requirements.

Unstable electricity will cause malfunction of the unit or give critical damage to the unit.

2. Several chips on the main board of the DVR unit and hard disk drive inside the unit generate heat, and it must be properly discharged.

Do not put any objects just beside exhaust port(fan) on the left side of the unit and do not close up an opening (fresh air in-take) on the right side of the unit..

3. Put the DVR unit at well-ventilated place and do not put heat-generating objects on the unit.

When it is installed inside 19 inch mounting rack together with other devices, please check built-in ventilation fan of the rack is properly running.

## Content

Safety Precautions.....	2
About this document.....	3
Before reading this document.....	3
Unit Description of Front Panel.....	5
Unit Description of Rear Panel.....	6
Installation.....	7
Function Setup.....	15
Login.....	15
Basic Operation.....	4
USB Data Read and Networking.....	39
Record Time Table: 80 GB HD.....	49
VGA Description (Optional) .....	50
Additional.....	51

## Unit Description of Front Panel

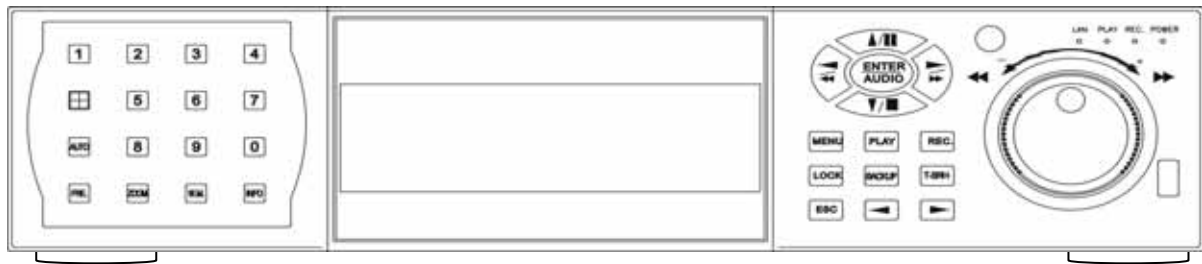

4 split screen



1 ~ 4 full screen / password



Sequence / Freezer / Zoom / Water Mark(PTZ mode) / Information



**MENU** button / **PLAY** button / **REC.** record button **LOCK** key lock button  
**BACKUP** data back up button / **T-SRH** time search playback button  
**ESC** function exit button



Value change button



Direction UP / Down,  
 Record and play stop,  
 Playback pause / steps.



Direction Left / Right  
 Playback forward or reverse.



ENTER / Audio ON or OFF

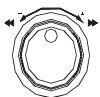

Playback forward / reverse  
 Function item change shuttle.

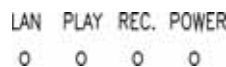

Function LED light display



Remote controller IR



USB. Data backup or firmware update

## Unit Description of Rear Panel

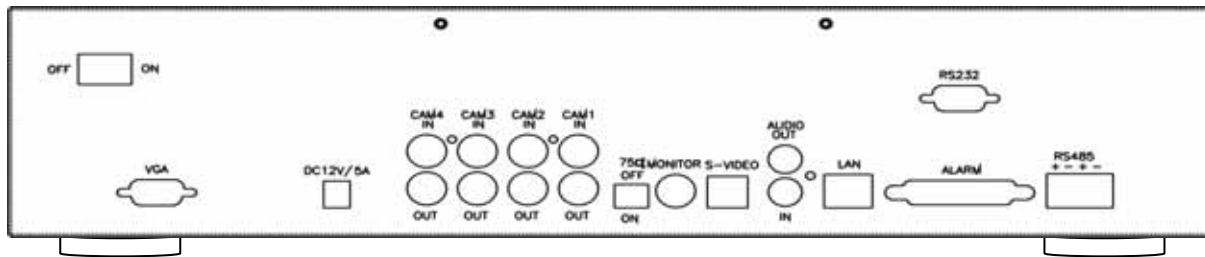

Power cord in 12V/5A, power switcher (ON / OFF)



Camera 1 ~ 4 in and looping out



75 Ohm ON/OFF (high/low adjust)



Audio channel input x 1 and output x 1



VGA output. PC monitor connector. (Optional)



Main Monitor



S-Video (Y/C) monitor



RS-485 Control keyboard connector



LAN. Network connector



RS-232 connector (ISP. For RD control)

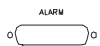

Alarm connector

**Notice: Reboot DVR after installing any device.**



NOTICE: Sensor input is RECOGNIZED as LOW when alarm signal is on a level with GND, and it is recognized as HIGH when alarm signal is FLOATING or 5V. Following is internal circuit.

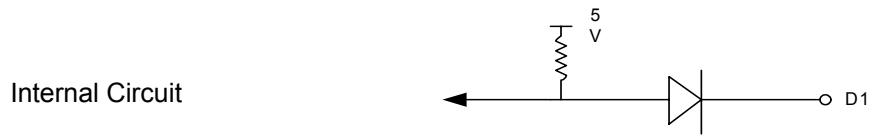

Thus, there is a danger of damage, when the sensor input goes to a Negative level or voltage higher than 5V.

### 5) Network Connection

DVR connects to LAN

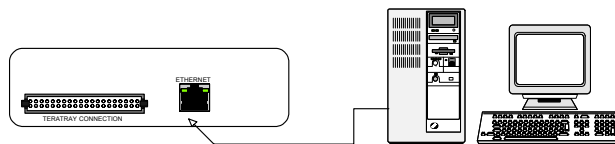

To view video image on the computer through internet with DVR view software.



## 5) HDD connection

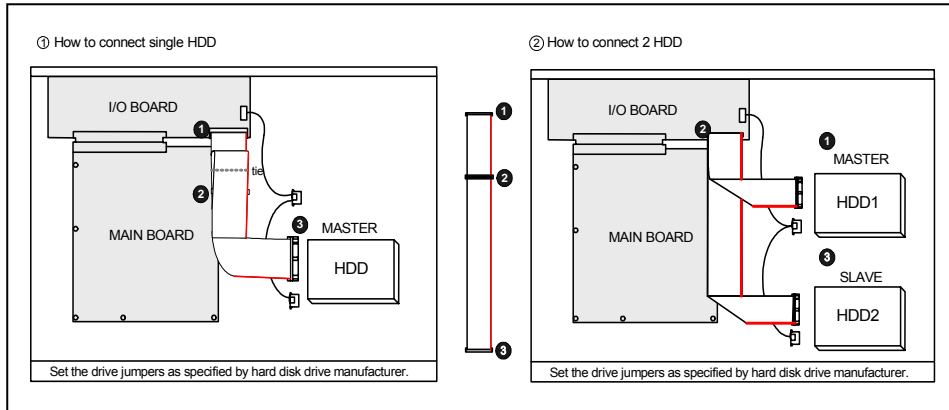

1. Make sure the HDD is MASTER.
2. Make sure the cable connector is correct.
3. Please check the HDD panel for Master set up.

1. Make sure the HDD is MASTER and SLAVE.
2. Make sure the cable connector is correct.
3. Please check the HDD panel for Master and Slave set up.

### Notice:

-Hard Disk Master and Slave jumper pin must right, otherwise it makes DVR work fault.

### Hard Disk testing table:

Brand	Model	Capacity	Notice
Seagate	Barracuda	80 GB	
IBM	DeskStar	80 GB	
WD2000	Caviar	200 GB	
Hitachi	DeskStar	80 GB	
Maxtor	MaxLinell	300 GB	



**Full screen or split screen display**

Press  button, to display 4 split screen.

Press numeric buttons  to display the desired camera image in full screen.

**1.) FREEZE Mode**

1. In live mode press  (FREEZE) button to freeze image.

2. Press  again to cancel freeze mode.

**2.) Zoom Mode(Display Enlargement.)**

Go to full screen mode with numeric buttons at live or playback mode, then press ZOOM button to display screen Enlargement.

Use  button to move position.

**3.) Auto Mode**

Press  (AUTO) button to start screen auto sequencing, and press it again to cancel auto mode.

**4.) W.MARK. Water Mark mode.**

Water Mark on to check if the data has modify.

**5.) INFO (System Information).** Auto disappear after 2 minutes if no any button operating.

**\*\* SYSTEM INFORMATION \*\***  
1.IP ADDR:  
2.GATEWAY:  
3.NETMASK:  
4.NET USER:  
5.HDD SIZE:  
6.HDD USED:  
7.STATUS1  
8.STATUS2  
9.UPTIME  
10.VERSION:

- 1. Network IP address
- 2. Network IP gateway
- 3. Network IP netmask
- 4. Network user amount
- 5. Hard disk capacity
- 6. Hard disk used percentage
- 7. First hard disk status
- 8. Video format
- 9. System running time
- 10. System version

**6.) BACKUP.** Image backup mode.(Image back up must be done on playback mode only.)

Locate the playback point of which you want. Press BACKUP, back up menu shows:

CDRW / USB

BACKUP MENU  
CDR WRITE SPEED  
START BACKUP TO CDR  
FORMAT USB  
START BACKUP TO USB

CDRW

BACKUP MENU  
  
CDR WRITE SPEED x1,x2,x3  
START BACKUP TO CDR

USB

BACKUP MENU  
  
FORMAT USB  
START BACKUP TO USB

USB:

The BACKUP CAUTION window pop-up. Press ENTER to begin data back up. Capacity of USB device is not limit.

On playback mode, presses BACKUP:

Lower-Right corner of the screen:

\*\* BACKUP CAUTION \*\*  
THE ORIGINAL BACKUP FILE  
WILL BE KILLED.  
PRESS [ENTER] TO BACKUP.  
PRESS [BACKUP] TO CANCEL.

xxx K

xxx K (Presently back up progress)

**Important:**

If DVR cannot detect USB device, please format it to FAT or FAT 32 on PC OS.

When the file is opened from a CF card, only DVR images will appear, but without sounds.

**Additional:**

During playback, USB device is full or user press BACKUP button screen display a "PAUSE" caption, User takes out the USB device to computer USB slot then save data to hard disk. After re-insert USB device to DVR slot, user press BACKUP again. Press ENTER to continue backup or backup button to cancel.

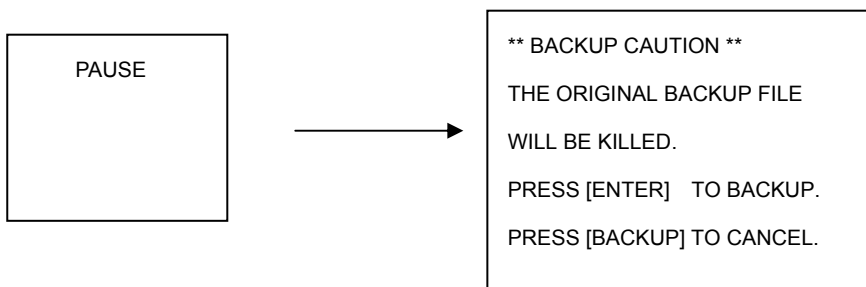

PS: NetViewer software auto copied to USB device when data backup. See the USB Data Read and Networking pages.

Compatible USB: Transcend 256 MB, 1 GB / A-DATA, 512MB / USB Flash Drive 128 MB / Intelligent Stick 256 MB / SOLOMON 128 MB / ISTECH 1GB.

**CD-RW:**

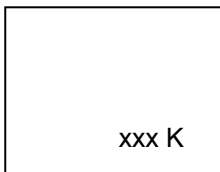

xxx K (Presently back up progress)  
 Press BACKUP to stop saving. Or wait for CD is full done.  
 Data only read in Netviewer.

**7.) Key Lock function**

>On the Live mode, press  (lock), Only, numeric, freeze, auto, and zoom buttons could work.  
 Press lock key again to enter the login-in window. Enter admin or user password to unlock.  
 Key lock function only accept password correct log in even re-boot DVR power.

**8.) AUDIO function ))))**

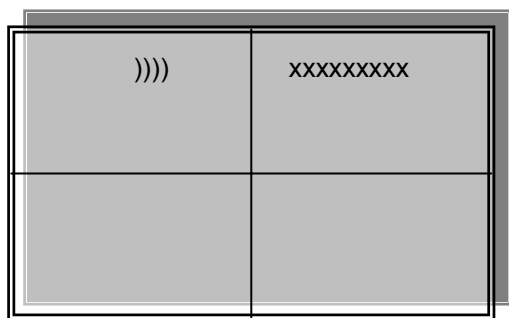

ENTER / AUDIO button

Audio playback: **AUDIO** ,  
 )))) displays on the Upper-left of screen. At that time, audio will playback. Press it again to turn it off.

**Notice**

Audio playback only on normal( x 1 ) playback.

**9. NETWORK Playing**

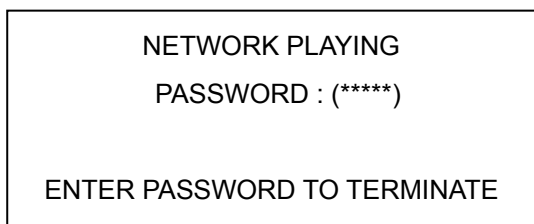

1. When the admin do playback mode on AP (Net Viewer), user can terminate it after into password of DVR. On AP client, admin needs to connect again.
2. When AP on playback mode, DVR is on playback mode also.

Playback

## 1. Playback Mode

- 1) Press  button to begin playback. (System playback the images backward)

## 2. T-SRH button

- 1) T-SRH: Playback by time search.  
Press T-SRH button to active playback function.

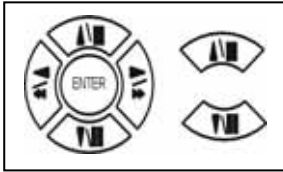

Press direction button  
UP/DOWN to choose  
items.



### 1) TIME LIST (Playback image by Time-Search): Recorded images list (by hours)

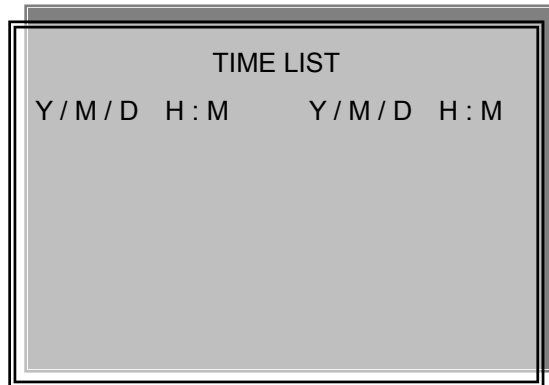



Y / M / D H : M (Beginning of recording time)      Y / M / D H : M (End of recording time)

Every playback data list displays by an hour.

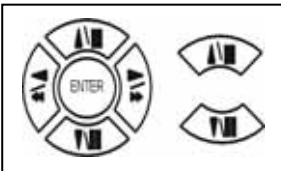
No page display limit. 10 items display on each page.



Press direction button UP/DOWN to choose items.

Press   values change button to change to previous / next page.

Notice:

Every playback data list displays by an hour, but if user finds out like:

1. 10:00 ~ 10:12
2. 10:12 ~ 11:00

Reason: 1. Hard disk is full. 2. User change record mode setup.

## 2) EVENT LIST (Alarm List): Event source- Video loss / Alarm trigger / Motion / Record



10 items display on each page / Total 5000 items display for 500 pages. When event list is out of compass, the total items are less than 5000.

NO Y / M / D H : M CH EVENT

>Event happens time and list.

CH: Event Channel Display.

>1 CH ~ 4 CH

+10 : Display pages by 10 units / +100 : Display pages by 100 units / +1000 : Display pages by 1000 units.

- Press direction button left and right to change +10 / +100 / +1000

Event type.

>Includes Motion / Alarm / V-Loss / Record / Power On / Event Full / Network (Network total users, include log in and log out.)

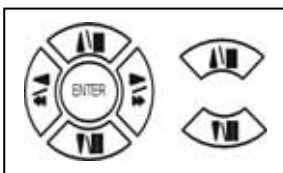

Press direction button UP/DOWN to choose items.

Press ◀ ▶ values change button to change page. Press ENTER to start playback.

### >Special time search playback:

Go TO DATE : 2 0 0 2 / 1 2 / 1 2

-Choose year / month / day

>Press direction button Left / Right to choose items, press values change button ◀ ▶ to change value.

GOTO TIME : 1 2 : 1 2

-Choose hour and minute

>Press direction button Left / Right to choose items, press values change button ◀ ▶ to change value.

GOTO PLAY

-Press ENTER button to start playback.

Notice: Playback speed change by ◀ ▶ or shuttle. Speed is x 1, x 2, x 4, x 8, x 4.

## Function Setup



LOGIN

- 1) Press  button to enter into menu. You could do the system function setup in MENU.
- 2) Password enter window pop-up:



Default password (Account-Admin) : 44444

Default password (Account-User) : 11111

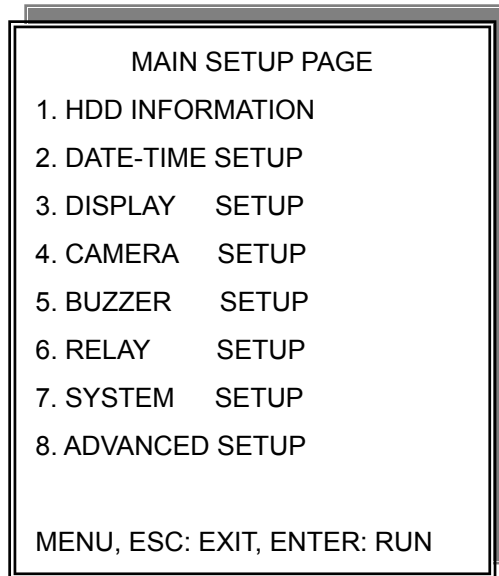

- 3) Press numeric (1 ~ 10 )button or remote controller ( 1 ~ 10 )to choose password.
- 4) Remote controller function buttons are same as DVR panel function buttons.

Press **MENU** button to enter **MAIN SETUP PAGE**.



1) Use direction button up/down  button to select setup item.

2) Press  button to enter into sub-menu function setup.

3) Press sub-menu item with direction button up/down   
or left/right  button.

And change the value with  values change button or turn inner-shuttle.

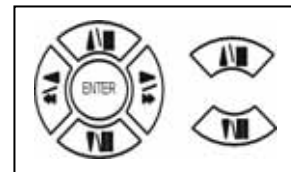

4) Press ESC to go back to main / sub menu or exit menu.

**Notice:**

1. ADMIN level can setup all DVR menu functions.
2. USER level cannot setup ADVANCED page of DVR main menu function.
3. Auto disappear after 4 minutes if no any button operating.



## 1. HDD INFORMATION

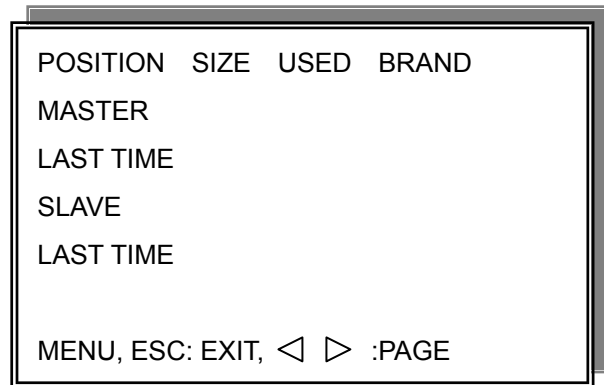
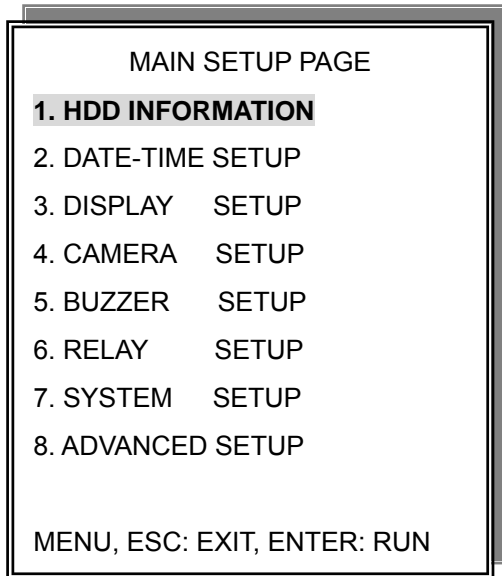

- 2 hard disk information display.

Information display: POSITION SIZE USED BRAND

>POSITION: Master / Slave

>SIZE: Hard Disk capacity. xxGB. Maximum display is 999MB

>USED: 00 ~ 100 %. Hard disk overwrites 100 ~ 199 %.

>BRAND: DVR auto detect hard disk brand.

>LAST TIME: The last record time display.

## 2. DATE-TIME SETUP

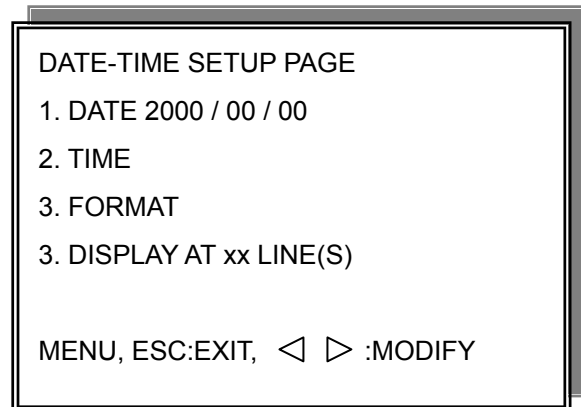
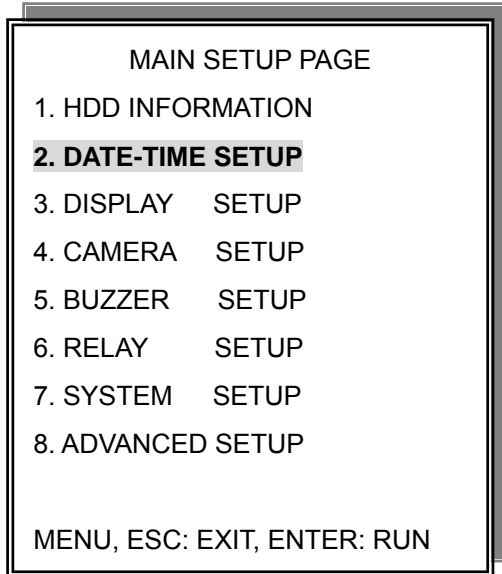

### 1. DATE

2. TIME: > Use direction button up/down choose position, values change button to change date and time values. Do not need to stop hard disk working (Play or record).

### 3. FORMAT:

YY/MM/DD, MM/DD/YY, DD/MM/YY, YY/ENG/DD, ENG/DD/YY, DD/ENG/YY, YYYY/MM/DD, MM/DD/YYYY, DD/MM/YYYY, YYYY/ENG/DD, ENG/DD/YYYY, DD/ENG/YYYY.

Y=Year. M=Month. D=Day. ENG=Month display in English.

### 4. DISPLAY AT xx LINE(S)

-Date and Time position on screen xx line(s). 00 ~ 23.

-. Day and time change



Press direction button up/down/left/right to choose items or move date-time position.

Press ◀ ▶ values change button to change values.

### 3. DISPLAY SETUP

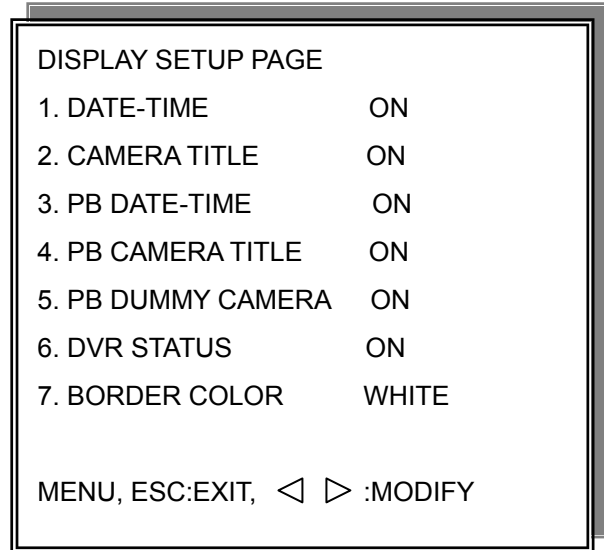
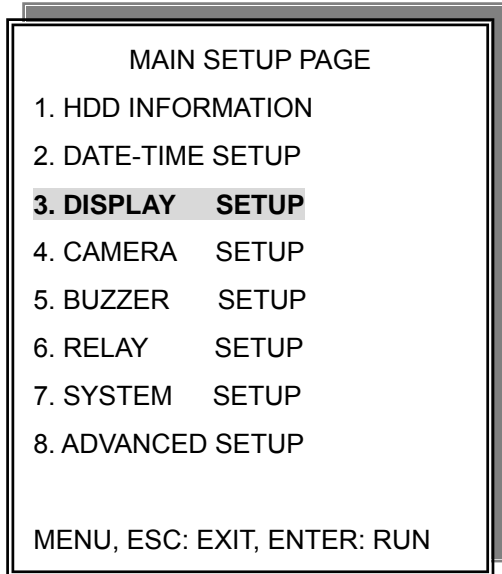

1. DATE-TIME: Date and Time caption display mode on or off setup.  
>ON / OFF
2. CAMERA TITLE: Camera Title caption display mode on or off setup.  
>ON / OFF
3. PB DATE-TIME: Play back date and time caption display mode on or off setup.  
>ON / OFF
4. PB CAMERA TITLE: Play back camera title caption display mode on or off setup.  
>ON / OFF
5. PB DUMMY CAMERA: To clear dummy image if channel input not up to 4.  
>ON / OFF
6. DVR STATUS: DVR system, record, playback, audio caption display mode on or off setup.  
>ON / OFF
7. BORDER COLOR: Border color WHITE / DARK / BLACK / GRAY.



Press direction button up/down to choose the desired item.

Press ◀ ▶ values change button to change values.

#### 4. CAMERA SETUP

MAIN SETUP PAGE

1. HDD INFORMATION
2. DATE-TIME SETUP
3. DISPLAY SETUP
- 4. CAMERA SETUP**
5. BUZZER SETUP
6. RELAY SETUP
7. SYSTEM SETUP
8. ADVANCED SETUP

MENU, ESC: EXIT, ENTER: RUN

CAMERA SETUP PAGE

1. COLOR SETUP
2. TITLE SETUP
3. SCREEN POSITION SETUP
4. V-LOSS DISPLAY SETUP
5. VIDEO MASK SETUP

MENU, ESC: EXIT, ENTER: RUN

>>DEFAULT RESET<<

MENU,ESC:EXIT, 71.66068 Tm(EXIT)Tj0 10.02 33

**(2.) TITLE SETUP:** Input TITLE of each camera. 9 characters can be input.

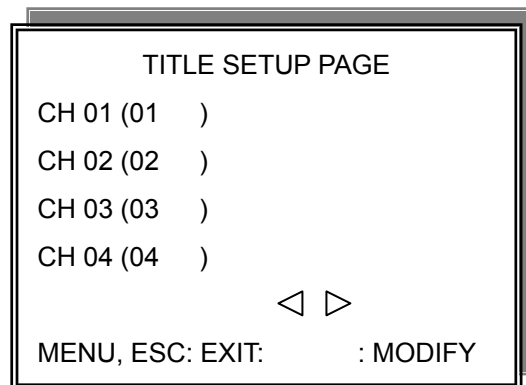
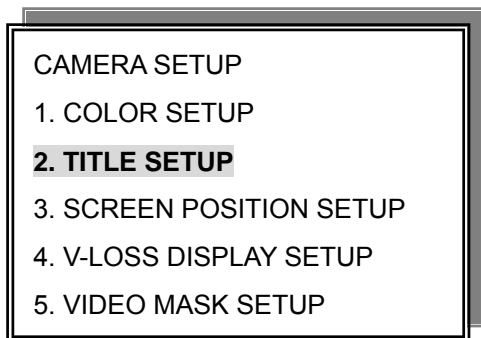

Press direction button up/down/left/right to choose items and position.

Press ◀ ▶ values change button to change values.

Characters choose:

Space:

Numeric: 0 / 1 / 2 / 3 / 4 / 5 / 6 / 7 / 8 / 9

Capital letter: A / B / C / D / E / F / G / H / I / J / K / L / M / N / O / P / Q / R / S / T / U / V / W / X / Y / Z

### (3.) SCREEN POSITION SETUP

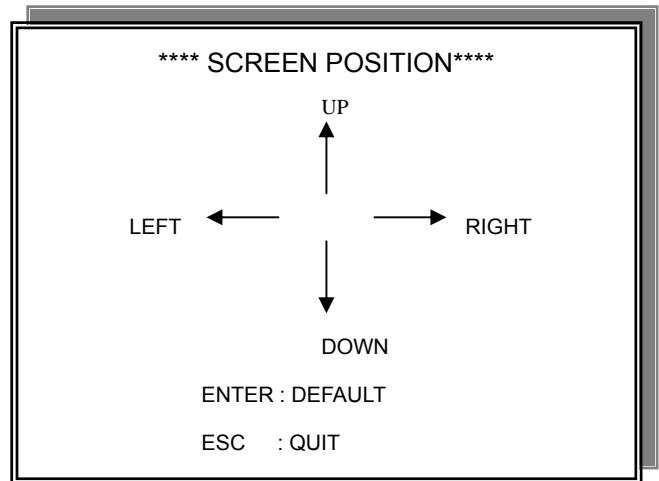
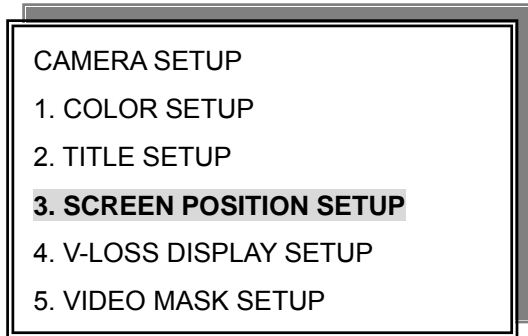

1.



Press direction buttons up/down/left/right to move screen position.

2. Press ENTER button for default.

3. Press ESC button to quit.

**(4.) V-LOSS DISPLAY SETUP**

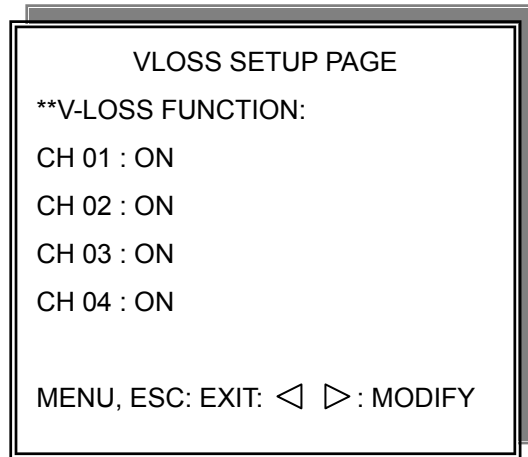
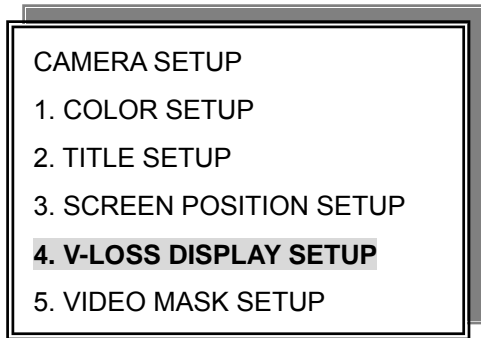

\*\* V-LOSS FUNCTION: ON / OFF

CH 01 : ON / OFF

CH 02 : ON / OFF

CH 03 : ON / OFF

CH 04 : ON / OFF

**PS. If choose on, X icon displays beside camera title.**



Press direction buttons up/down/left/right to choose items.



Press values change button to change values.

(5.) VIDEO MASK SETUP

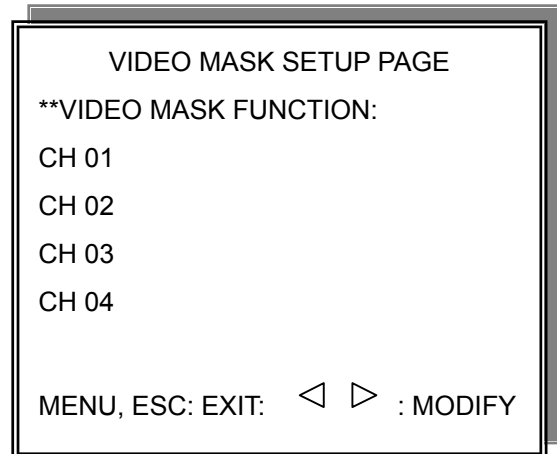
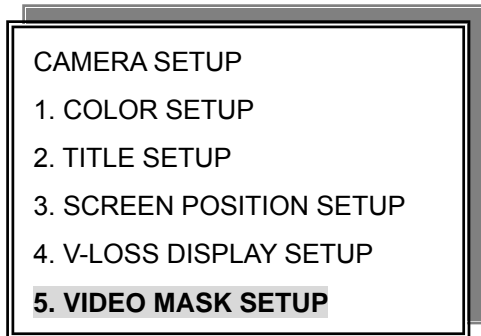

\*\*VIDEO MASK FUNCTION: ON / OFF

CH 01 : ON / OFF

CH 02 : ON / OFF

CH 03 : ON / OFF

CH 04 : ON / OFF

MASK means the channel would not display on the live screen, but still can set it on recording.



Press direction buttons up/down/left/right to choose items.



Press values change button to change values.



## 5. BUZZER SETUP

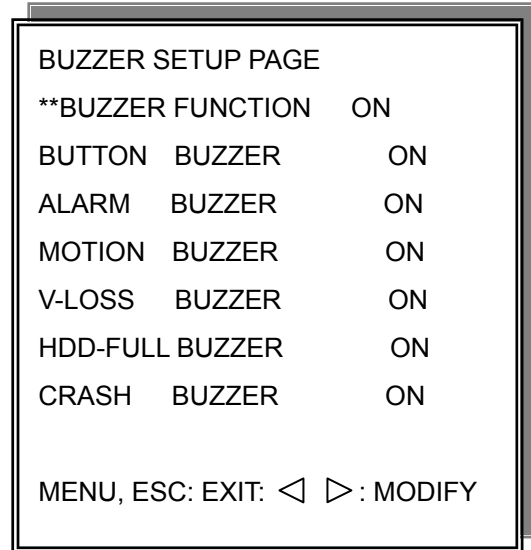
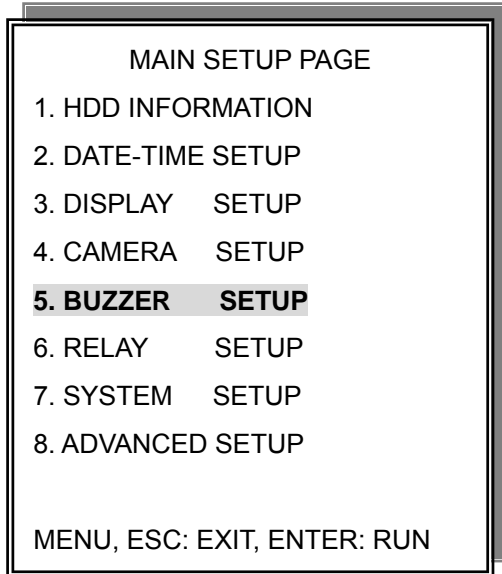

\*\*BUZZER FUNCTION: All buzzer function

>ON / OFF

1. BUTTON BUZZER?

> ON / OFF

2. ALARM BUZZER?

> ON / OFF

3. MOTION BUZZER?

> ON / OFF

4. VLOSS BUZZER?

> ON / OFF

5. HDD-FULL?

> ON / OFF (Buzzer on if hard disk record only once(Record setup→ HDD FULL→STOP REC.)

6. CRASH?

> ON / OFF (Buzzer on if DVR system or hard disk crash.)



Press direction buttons up/down to BUZZER SETUP items.



Press values change button to change values.

## 6. RELAY SETUP

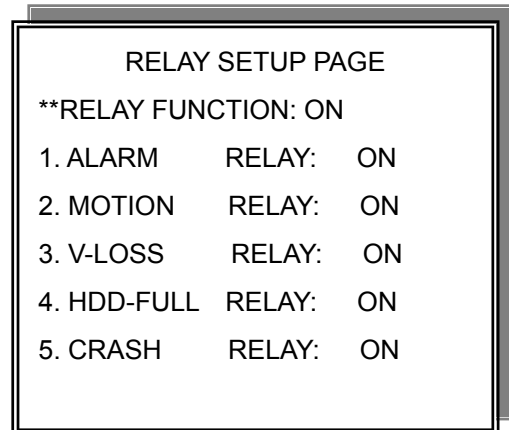
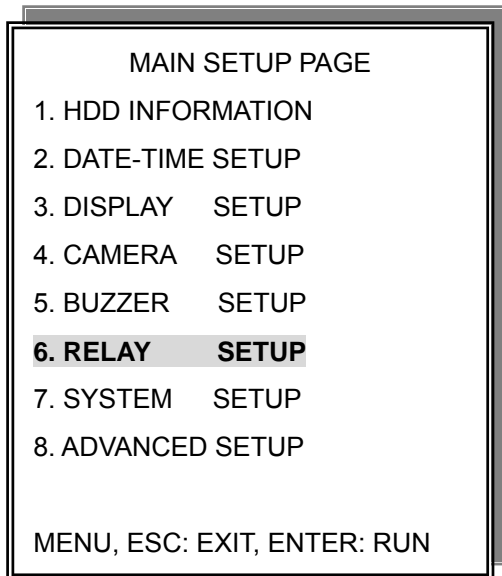

\*\*RELAY FUNCTION: ON

1. ALARM RELAY: ON
2. MOTION RELAY: ON
3. VLOSS RELAY: ON
4. HDD FULL RELAY: ON (Relay on if hard disk record only once.)  
Record setup→ HDD FULL→STOP REC.
5. CRASH RELAY: ON (Relay on if DVR system or hard disk crash.)



Press direction buttons up/down to each item.



Press values change button to change values.

## 7. SYSTEM SETUP

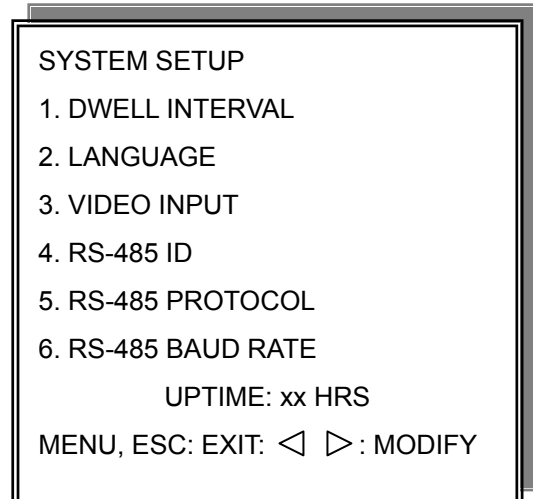
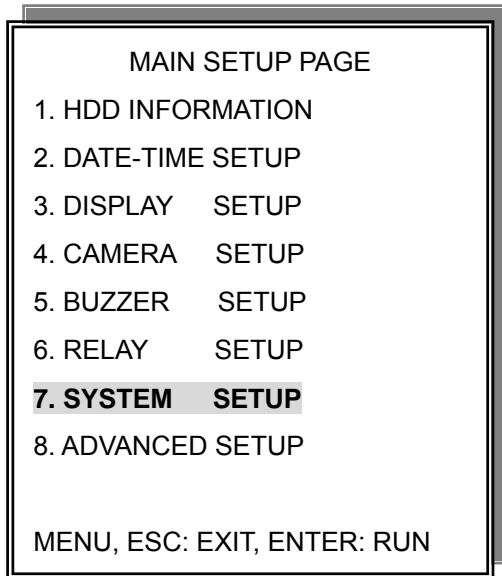

### SYSTEM SETUP

1. DWELL INTERVAL:
  - 0 ~ 999SEC. Full channel and call monitor auto sequence time.
2. LANGUAGE:
  - ENGLISH / CHINESE / JAPANESE / FRENCH
  - After change language, user needs to exit menu. Language would change next time back to menu.
3. VIDEO INPUT: NTSC / PAL system detection.
  - AUTO / NTSC / PAL
  - User needs to re power on after change.
4. RS-485 ID:
  - 01 ~ 4
5. RS-485 PROTOCOL
  - KEYB / LILIN / PELCO-P / PELCO-D / NICECAM / DENTEC-D / DENTEC-P
6. RS-485 BAUD RATE
  - 1200 / 2400 / 4800 / 9600

-UPTIME: xx HRS. This means the total system working time after DVR first power on.

**RS-485 ID and protocol is the command for system control keyboard. If user has no keyboard to control then does not have to care.**



Press direction buttons up/down to choose items.



Press values change button to change values.

## 8. ADVANCED SETUP

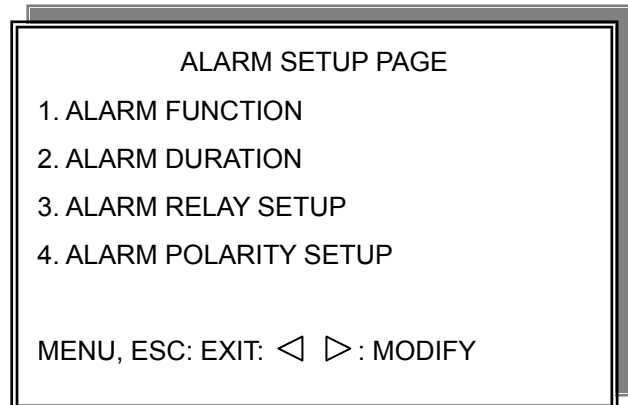
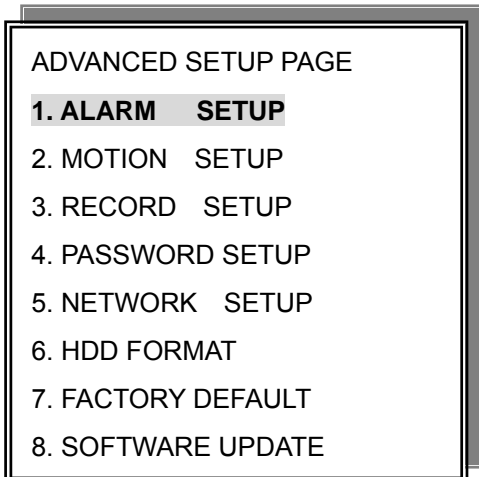
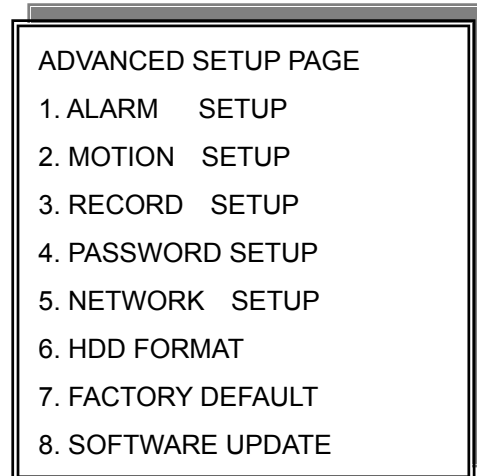
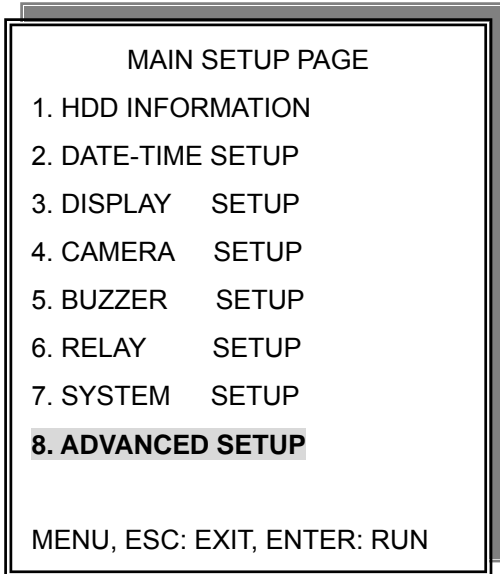

1. Alarm function: ON / OFF. Alarm function on or off depends on alarm device includes in DVR system.

2. Alarm duration: 10 ~ 999. Alarm buzzer and record duration time.

### ALARM RELAY SETUP

>ALARM 01 ~ ALARM 04: ON / OFF

Even choose on, but RELAY SETUP→Alarm relay or relay function off, this function is still closed.

### ALARM POLARITY SETUP

>ALARM 01 ~ ALARM 4: N.O. / N.C. / OFF



Press direction buttons up/down to choose items.



Press values change button to change values.

## 2. MOTION SETUP

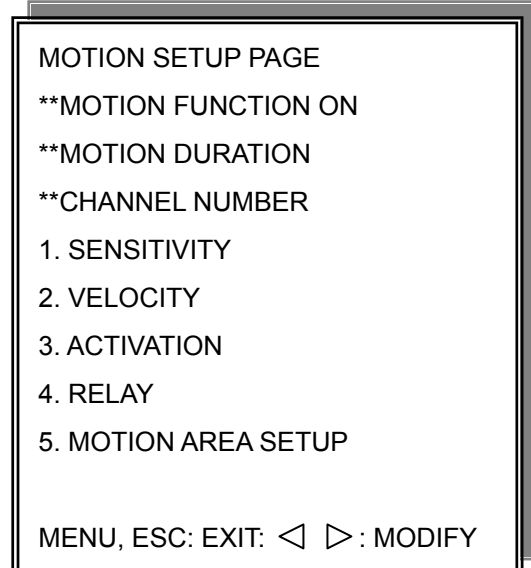
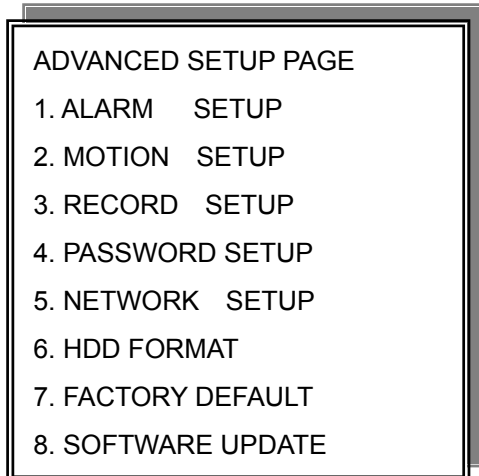

### MOTION SETUP

\*\*MOTION FUNCTION (For all channels)

-ON / OFF

\*\*MOTION DURATION

-10 ~ 999. Motion buzzer and record duration time.

\*\*CHANNEL NUMBER

-CH 01 ~ 04

1. SENSITIVITY Adjusts motion Detection Sensitivity.

-1 ~ 32 (low →high)

2. VELOCITY Adjusts motion object slow /fast speed detection

-1 ~ 10 (slow speed→fast speed)

3. ACTIVATION (For each channel)

-ON / OFF. The function only for channel motion detect active, not for motion record per each.

4. RELAY

-ON / OFF

Even choose on, but RELAY SETUP→Motion relay or relay function off, this function is still closed.

5. >MOTION AREA SETUP<



Press direction buttons up/down to choose items.



Press values change button to change values.

> MOTION AREA SETUP <

All area detect with factory default. Press ENTER button to change mode and then increase or reduce.

For example:

Clear lattices  $\longleftrightarrow$  Press value change button to reduce.  $\triangleleft$

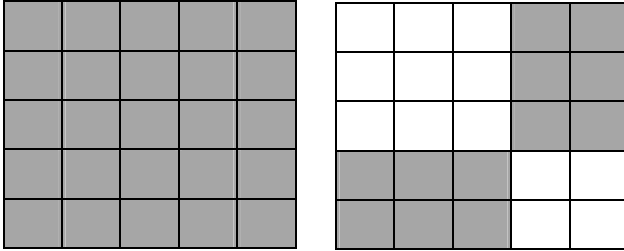

Press value change button

### 3. RECORD SETUP

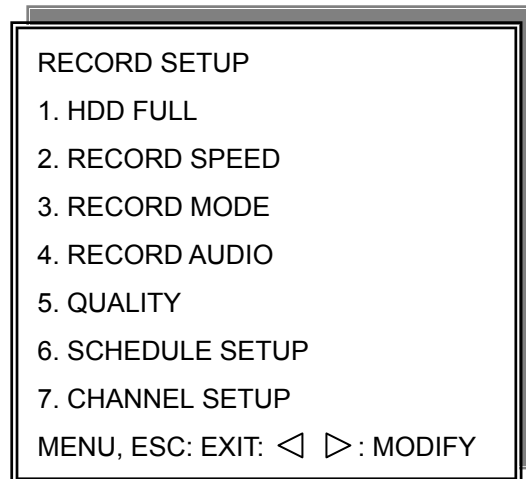
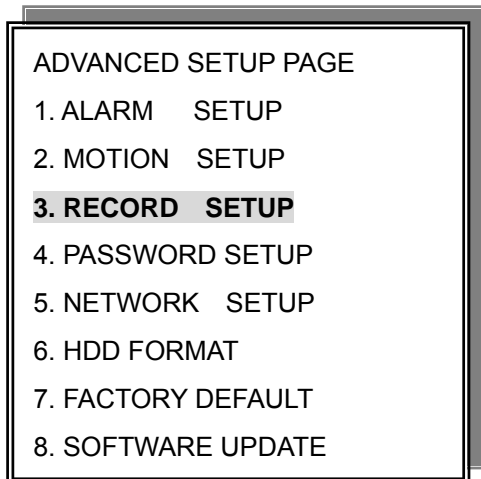

#### RECORD SETUP

- 1) HDD FULL: When hard disk is full, DVR next step is kept overwrite record or stop record?  
 -OVERWRITE / STOP REC

Notice: STOP REC : One hard disk record full, stop record. Two hard disk, both of them record full, stop record.

Record process	OVERWRITE	STOP REC
M(99%), S(0%) → M(100%), S(0%)	To second and record	To second and record
M(99%), S(100%) → M(100%), S(100%)	To second and record	To second and record
M(0%), S(99%) → M(0%), S(100%)	To first and record	To first and record
M(100%), S(99%) → M(100%), S(100%)	To first and record	Stop record

Notice:

When hard disk is full, system buzzer on, and then presses ENTER to stop. Next to press REC, over write message window popup.

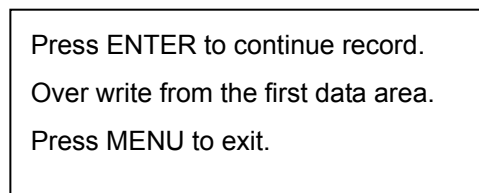
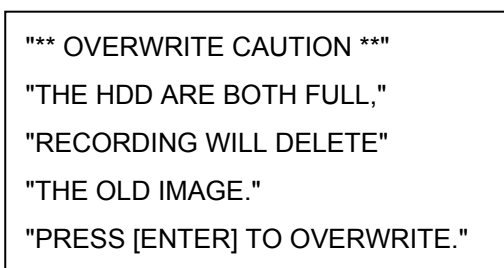

- 2) RECORD SPEED: Record FPS setup  
 -1/30(1/30), 1/15(1/15), 1/10(1/10), 1/5 (1/5), 1/3 (1/3), 1/2 (1/2), 1(1), 2(2), 3(3.13), 5(5), 10 (8.33), 15(12.5), 30(25), 60(50), 120(100). NTSC / (PAL)
- 3) RECORD MODE: Record mode setup.  
 -ALWAYS / SCHEDULE / EVENT / EVENT ON SCHEDULE / EVENT + SCHEDULE
- 4) RECORD AUDIO: Audio record setup  
 -ON / OFF. (Suggest not fewer than 5 fps.)
- 5) QUALITY: Record image quality setup  
 - SUPER / HIGH / FINE / NORMAL / LOW
- 6) SCHEDULE SETUP
- 7) CHANNEL SETUP: CH01 ~ CH04 record on or off.



Press direction buttons up/down to choose item.



Press values change button to change values.

**Additional:**

2. RECORD SPEED. 1/30(1/30), 1/15(1/15), 1/10(1/10), 1/5 (1/5), 1/3 (1/3), 1/2 (1/2), 1(1), 2(2), 3(3.13), 5(5), 10 (8.33), 15(12.5), 30(25), 60(50), 120(100).

- 120 is the maximum fps. Full screen playback with 120 frames per each.
- Split screen playback with 60 frames.

3. RECORD MODE. ALWAYS / SCHEDULE / EVENT / EVENT ON SCHEDULE / EVENT + SCHEDULE.

- Always: 24 hours recording.
- Schedule: Date and time schedule recording mode.
- Event: Alarm / Motion / V-Loss event mode recording. (Whatever which channel event, all channel record.)
- Event on schedule: Event record only on schedule time.
- Event + Schedule: Except event on schedule recording, it would still do record if event happens not on schedule time.

**Notice:**

After record mode setup, user needs to press REC button to start. Set on Always mode, DVR do record if user presses REC. Other record mode would ready on DVR idle status.

4. RECORD AUDIO: ON / OFF.

- Choose on, DVR would do audio recording.



>SCHEDULE SETUP<

RECORD SETUP

1. HDD FULL
2. RECORD SPEED
3. RECORD MODE
4. RECORD AUDIO
5. QUALITY
- 6. SCHEDULE SETUP**
7. CHANNEL SETUP



Press direction buttons up/down to SCHEDULE items.



Press values change button to change values.

Factory default is everyday all schedules time on recording.

**SCHEDULE SETUP**

CURSOR STEP

30MIN / 6MIN >>>

**SUN**

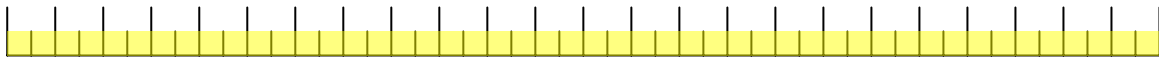

**MON**

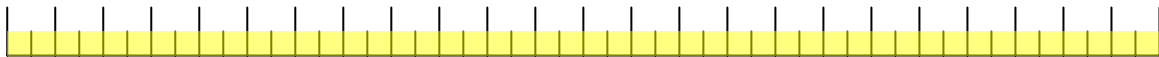

**TUE**

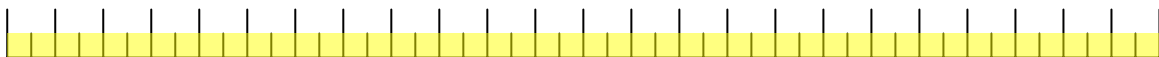

**WED**

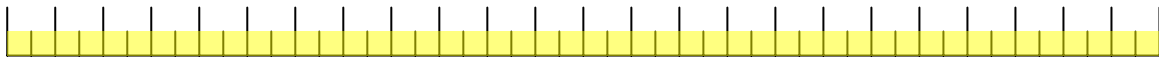

**THU**

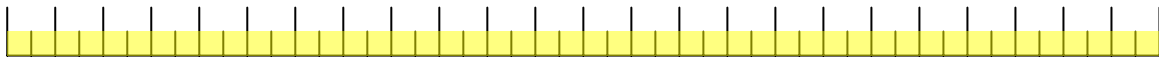

**FRI**

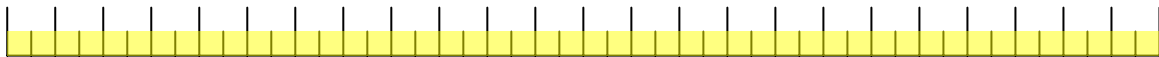

**SAT**

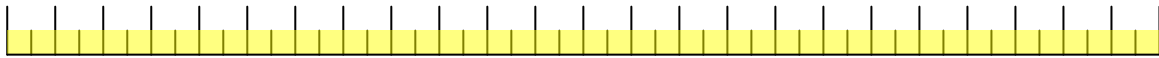

Press direction buttons up/down/left/right to see date and time difference.



Press values change left/right button to change 30MIN or 6 MIN

++ / -- : Increase / Reduce. Every day record with factory default.

On >>>, use up/down button to choose date, press <> button to change on

++ or --. After, use direction left / right button to start increase or reduce time area.

Mode function button

++ increase

-- reduce

CURSOR STEP

**SUN**

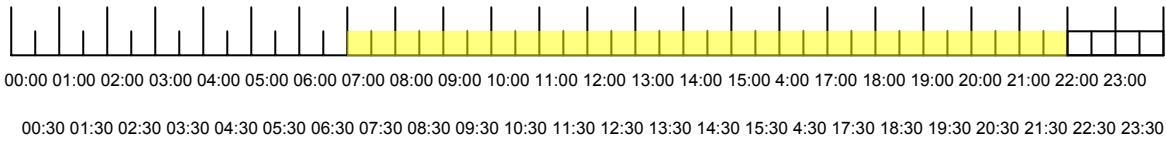

**MON**

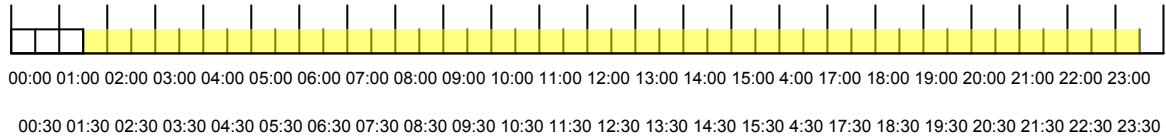

**TUE**

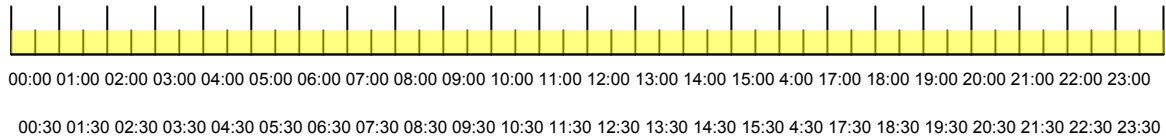

**WED**

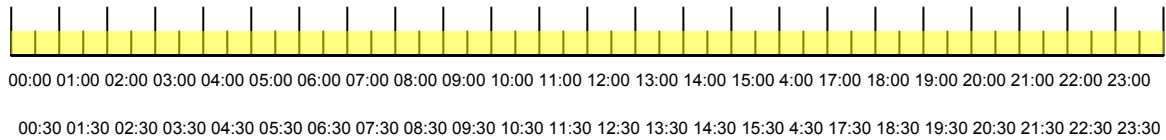

**THU**

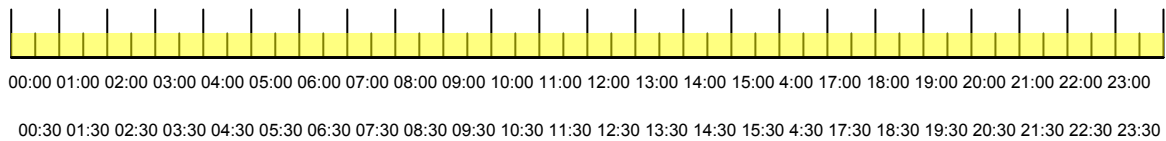

**FRI**

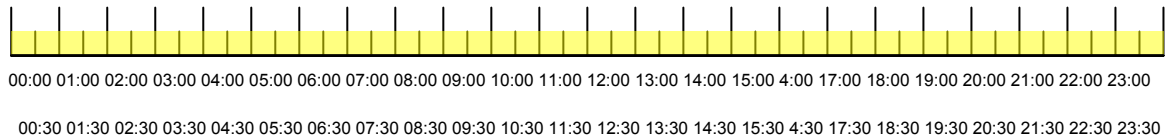

**SAT**

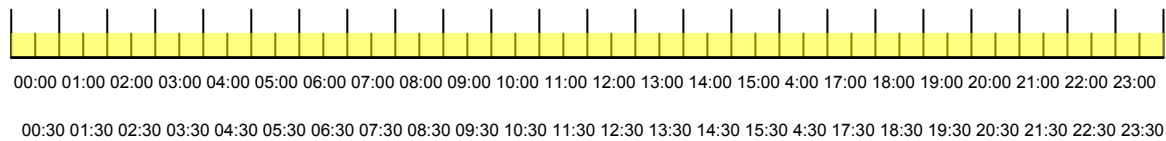

For example:

TUE ~ SAT, all day schedule time recording, but SUN 07:00 ~ 22:00 and MON 01:30 ~ 11:30 do schedule recording. User can press ENTER to see the schedule time area difference.

## 7) RECORD CHANNEL SETUP PAGE

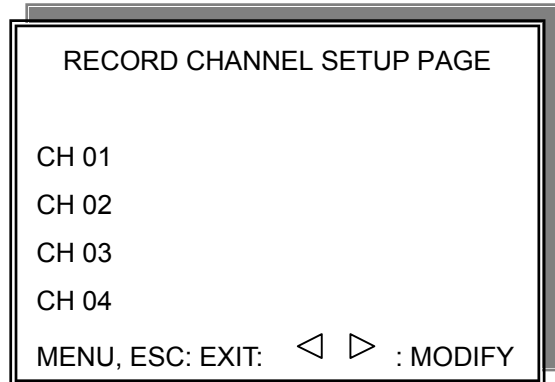
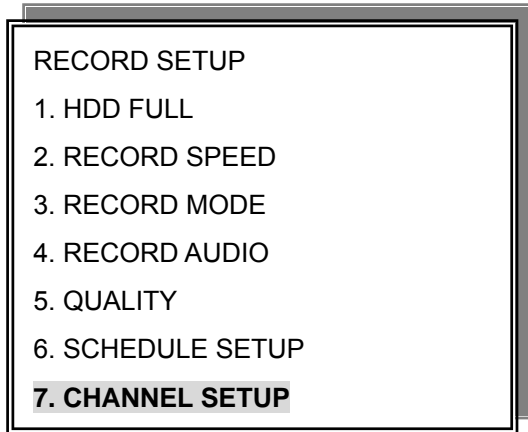

CH 01 : ON / OFF

CH 02 : ON / OFF

CH 03 : ON / OFF

CH 04 : ON / OFF

PS. Choose off if no video input channel or which channel would not do record.

According to channel record, record time would different.



Press direction buttons up/down to choose item.



Press values change button to change values.

#### 4. PASSWORD SETUP

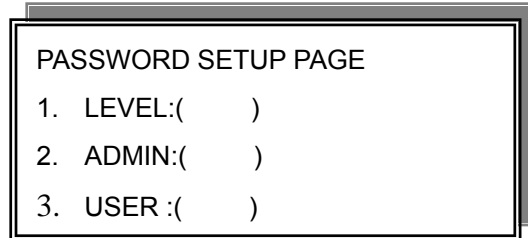
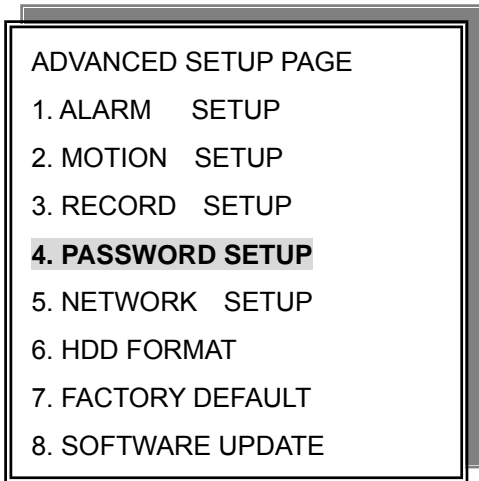

- 1) LEVEL (Log In level ID type setup)  
>NONE / ADMIN / USER



Press direction buttons up/down/left/right to  
Choose items position.

-ADMIN

-USER



Press values change button to change values.

-NONE, user does not need to insert password before enter in MENU.

- 2) ADMIN password  
>44444 (Factory Default)

Notice:

Password always 5 character input, cannot < 5 characters

- 3) USER password  
>11111 (Factory Default)



Press direction buttons up/down/left/right to choose items position.

Press numeric (1 ~ 10 )button or remote controller ( 1 ~ 10 )to choose

**Notice:**

1. ADMIN level can setup all DVR menu functions.
2. USER level cannot setup ADVANCED page of DVR main menu function.
3. Auto disappear after 4 minutes if no any manual operate.

## 5. NETWORK SETUP

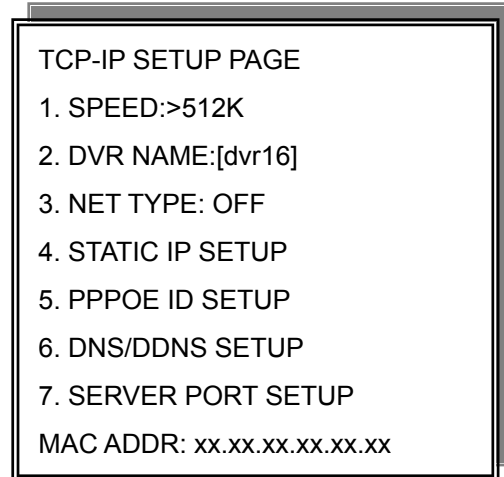
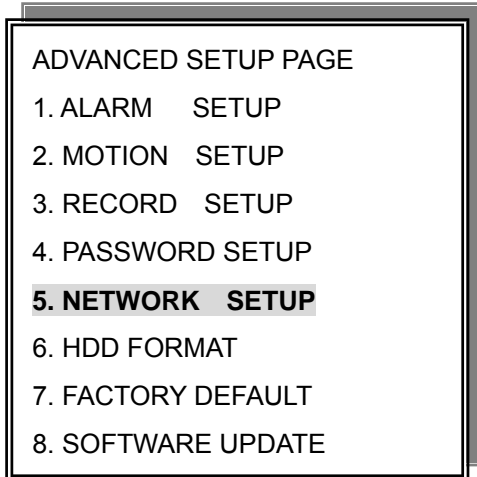

1. SPEED : >512K / 512K / 256K / 128K / 64K

> Upload speed. Choose the close speed by applied.

2. DVR NAME: [ x 15 space ]

3. NET TYPE: STATIC / DHCP / PPPOE / OFF

4. STATIC IP SETUP

5. PPPOE ID SETUP

6. DNS/DDNS SETUP

7. SERVER PORT SETUP



Press direction buttons up/down/left/right to TCP-IP items position.



Press values change button to change values.

-MAC ADDR

XX.XX.XX. Machine number, user cannot change.

2. DVR NAME: see DDNS apply.

3. NET TYPE:

> choose network connecting type as user.

4. STATIC IP SETUP:

> Depends on LAN or WAN. Input value witch get from network technician or ISP company.

> Advice user apply network speed Upload 512K / Download 512K, to avoid image data too big influence the remote quality. The network traffic jam always make data transfer slow, it is normal.

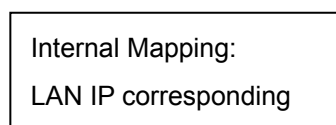
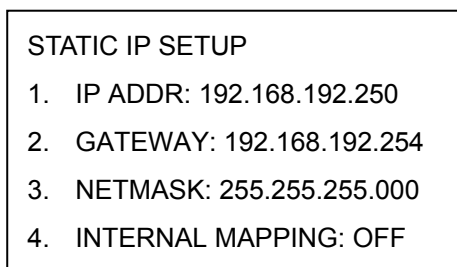

## 5. PPPOE ID SETUP

If users apply the dynamic IP from ISP, then should input ID and password that from ISP information list. And then go to set DNS/DDNS SETUP

For example:

Address name is [123456@hinet.net.tw](mailto:123456@hinet.net.tw)

Password is 654321

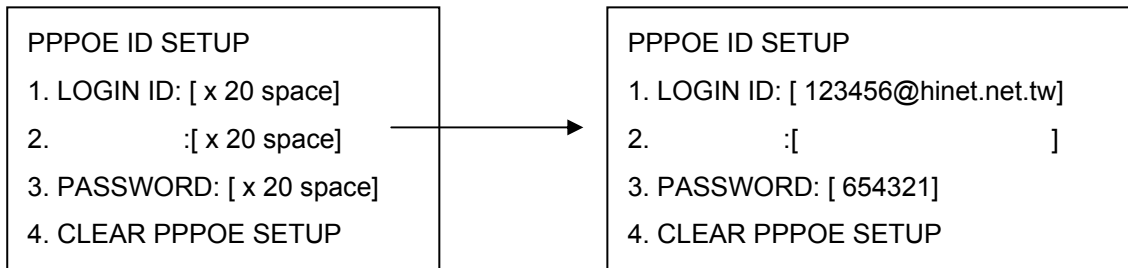

Or

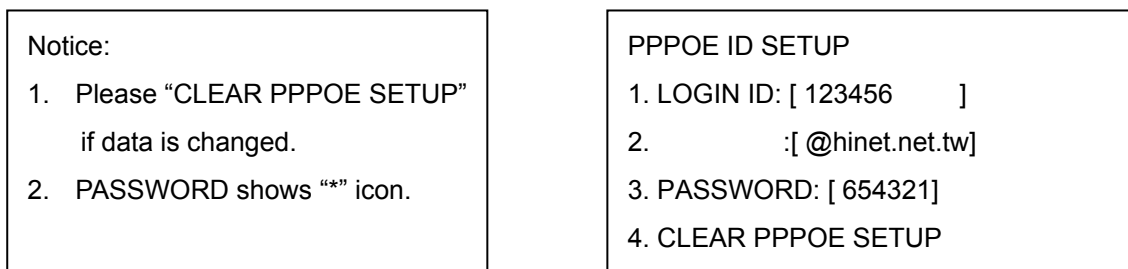

## 7. SERVER PORT SETUP

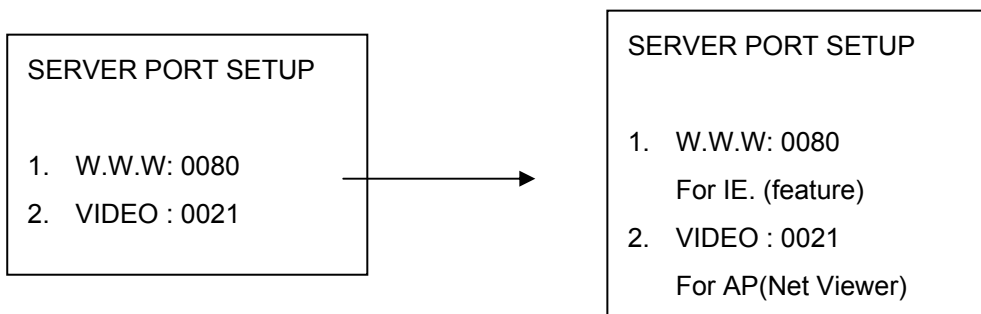

## 6. DNS/DDNS SETUP

Whatever user apply a free or pay DDNS, user needs to input every thing below.

DDNS apply: User can get a free hostname or pay from website below.

1. <http://www.3322.net/> (China)
2. <http://www.changeip.org/>
3. <http://www.dyndns.com/>
4. <http://www.no-ip.com/>
5. <http://www.dhs.org/>
6. <http://www.dtdns.com/index.cfm?fuseaction=info.hosts>

For example:

Go to: <http://www.dtdns.com/index.cfm?fuseaction=info.hosts>

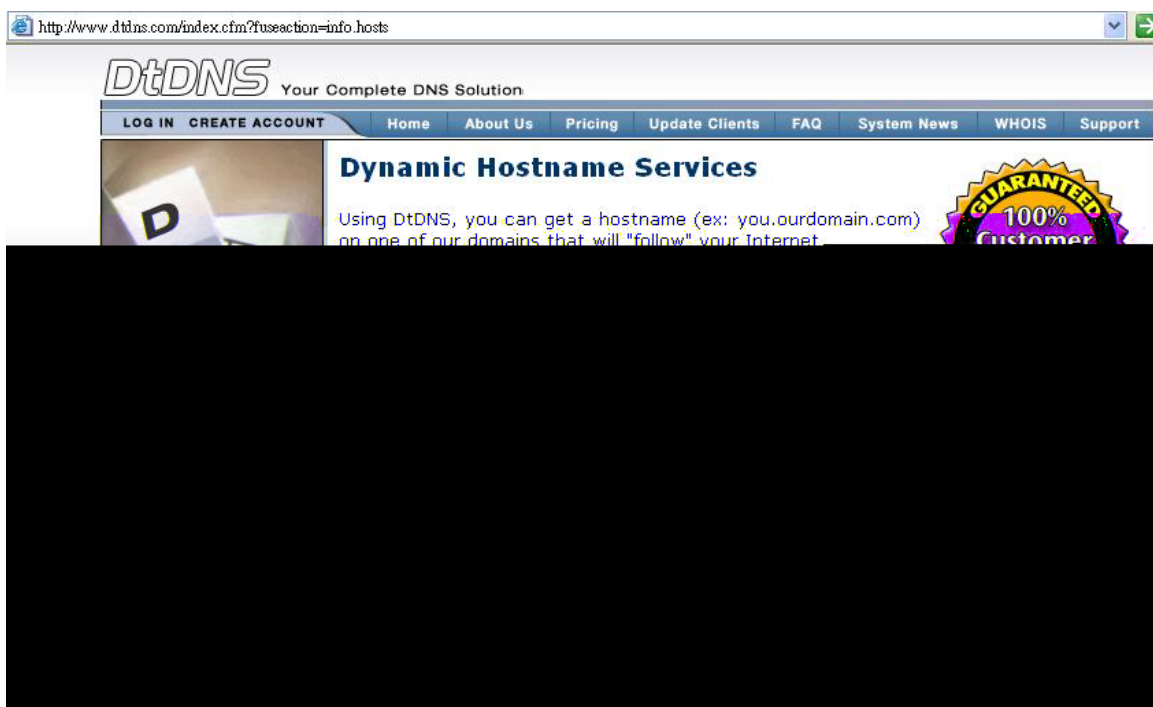

MX records for your hostname. Define up to 4 MX records for your hostname and point them any server you would prefer your e-mail to be delivered to. This feature is fully compatible with web-based e-mail service from providers like Everyone.net.

- **Heartbeat Monitor** - If you have an unreliable Internet connection, DtdNS can automatically set your hostname as being "offline" if an IP update is not sent to our server within a specified time limit. This will cause your web visitors to see your offline notice instead of not being able to connect at all.
- **Cloaked URL Redirection** - Hostnames also have the ability to cloak the offline URL redirection using a browser. You can also define the title and meta tags for the main frame.

Don't want a hostname? DtdNS also offers DNS service for [full domain names](#).

[Sign up now!!!](#)

Please read our [Privacy Statement](#) and [Terms of Service](#).  
Copyright © 1999-2005 by [Sceiron Interactive, Inc.](#)  
Powered by [Sceiron - Sarasota Web Design](#)

Click sign up to create an account.

Fill your information to sign up paper.

**Please enter your information:**

Desired Username:	<input type="text" value="Max"/>
Desired Password:	<input type="password" value="••••••"/>
Your Full Name:	<input type="text" value="Max Chen"/>
Company:	<input type="text" value="DVR"/>
E-mail Address:	<input type="text" value="maxchen@hxxxx.com.tw"/>
Address:	<input type="text"/>
City:	<input type="text" value="Taiwan"/>
State or Province:	<input type="text" value="Foreign"/>
Zip/Postal Code:	<input type="text" value="03"/>
Country:	<input type="text" value="Taiwan (China Rep of)"/>
Phone Number:	<input type="text" value="0921xxxxxx"/>
Confirm Password:	<input type="password" value="••••••"/>
Confirm E-mail:	<input type="text" value="maxchen@hxxxx.com.tw"/>

I am at least 13 years old at this time.  
 I have read and agree to be bound by the [Terms of Service](#).  
 I would like to be informed of DtdNS news and updates.

After, go to email account to get activate ID and code.

Hello Max Chen,

DtdNS has received a request to create a new account, and this e-mail address was entered with it. We apologize now. Otherwise, welcome to DtdNS! If you have a question, comment, problem or suggestion, please feel free to contact us.

When you signed up for our service, you entered the following information:

---  
Username : M[redacted]id  
E-mail address : maxchen@h[redacted].com.tw  
Activation Code : dx[redacted]4  
---

The above code was assigned to your account when you created it.  
To activate your account, you must visit the url below within 48 hours.  
Accounts not activated within 48 hours are removed.

<https://www.dtdns.com/index.cfm?fuseaction=account.activate> ← Click here to active

Enter your username and activation code on that page. Further instructions will be indicated there.





**Fill ID and code.**

## Step 2 - Activate Account

Now that you have signed up with DtDNS and we have sent you a verification message via e-mail, you must activate your account. The message we sent you contained an activation code, which you will need to enter below.

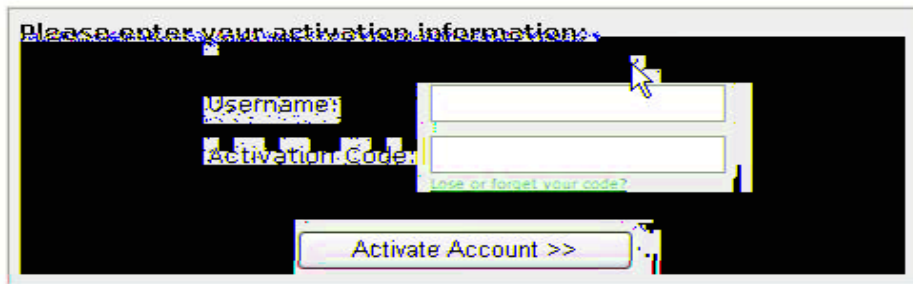
If it has been more than 48 hours since you signed up, you will need to [sign up](#) again and get a new activation code.



 Please read our [Privacy Statement](#) and [Terms of Service](#).

**Click hostnames**

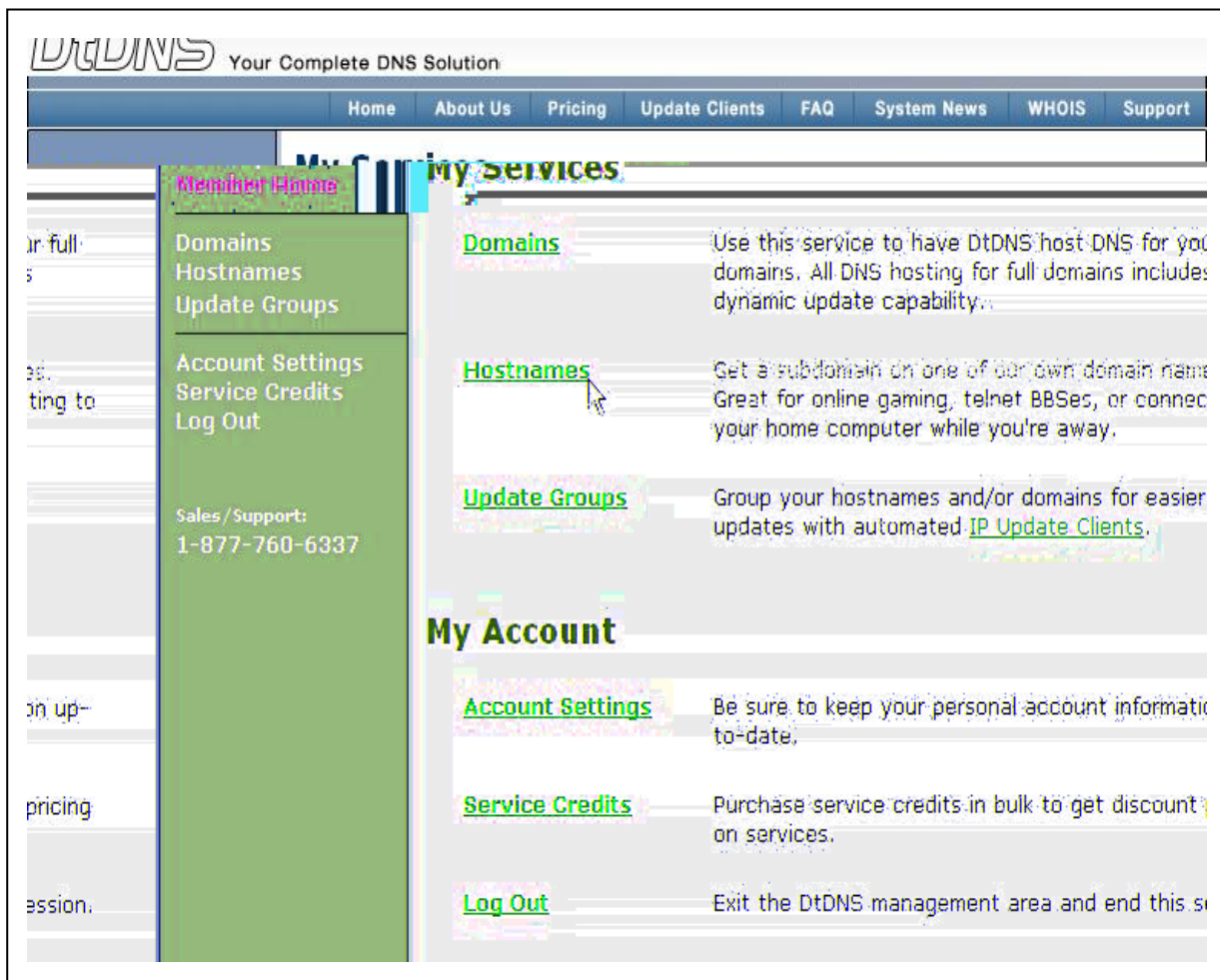

**Member Home**

- Domains
- Hostnames
- Update Groups
- Account Settings
- Service Credits
- Log Out
- Sales/Support: 1-877-760-6337

**My Account**

- Domains** Use this service to have DtDNS host DNS for your domains. All DNS hosting for full domains includes dynamic update capability.
- Hostnames** Get a subdomain on one of our own domain names. Great for online gaming, telnet BBSes, or connect your home computer while you're away.
- Update Groups** Group your hostnames and/or domains for easier updates with automated [IP Update Clients](#).

**My Account**

- Account Settings** Be sure to keep your personal account information up-to-date.
- Service Credits** Purchase service credits in bulk to get discounts on services.
- Log Out** Exit the DtDNS management area and end this session.

Type Hostname and choose a domain name, and then click Add Hostname.

EX: Hostname = Myhostname, Domain = 4irc.com

The screenshot shows the DtdNS Hostname Manager interface. On the left is a navigation sidebar with links for Member Home, Domains, Hostnames, Update Groups, Account Settings, Service Credits, and Log Out. The main content area is titled "Hostname Manager" and contains a message about account limitations and a table of existing hostnames. A dropdown menu is open over the "Add Hostname >>" button, showing a list of domain options including .4irc.com, which is highlighted by the mouse cursor.

Hostname	Domain	IP Address	Type
Digital4CHDVR	gotgeeks.com	203.70.247.28	Active Dynamic

After click Add Hostname>>

This screenshot shows the same DtdNS Hostname Manager interface, but the dropdown menu is now closed. The "Add Hostname >>" button is highlighted with a mouse cursor. The form fields for "Myhostname" and ".4irc.com" are visible, indicating that the user has entered the hostname and selected the domain.

Hostname	Domain	IP Address	Type
Digital4CHDVR	gotgeeks.com	203.70.247.28	Active Dynamic

Data confirm done, then you can go to DVR advanced setup → Network setup now.

Advanced setup → TCP-IP SETUP

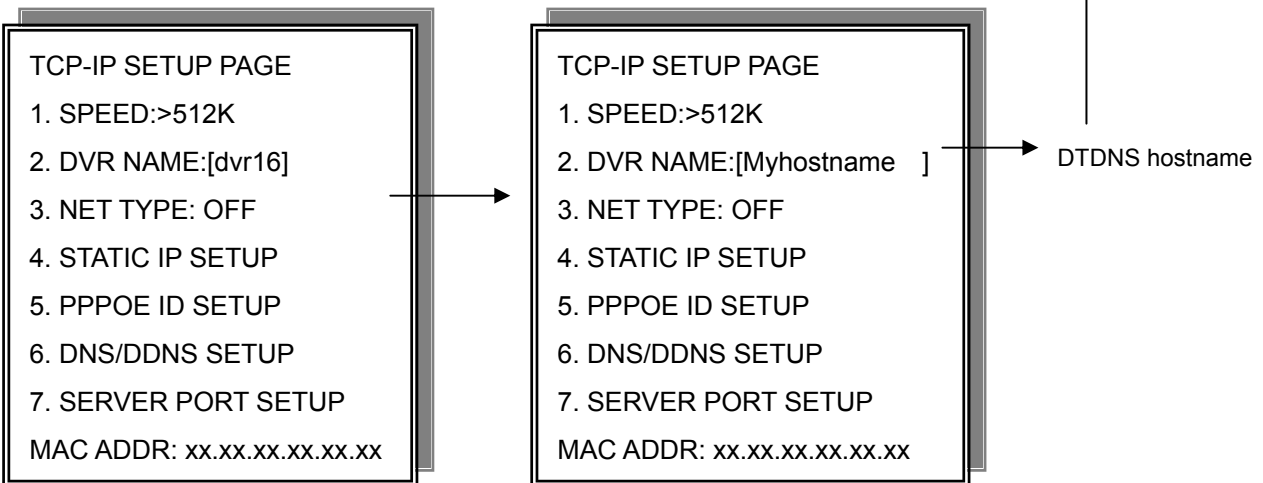

## 6. DNS/DDNS SETUP

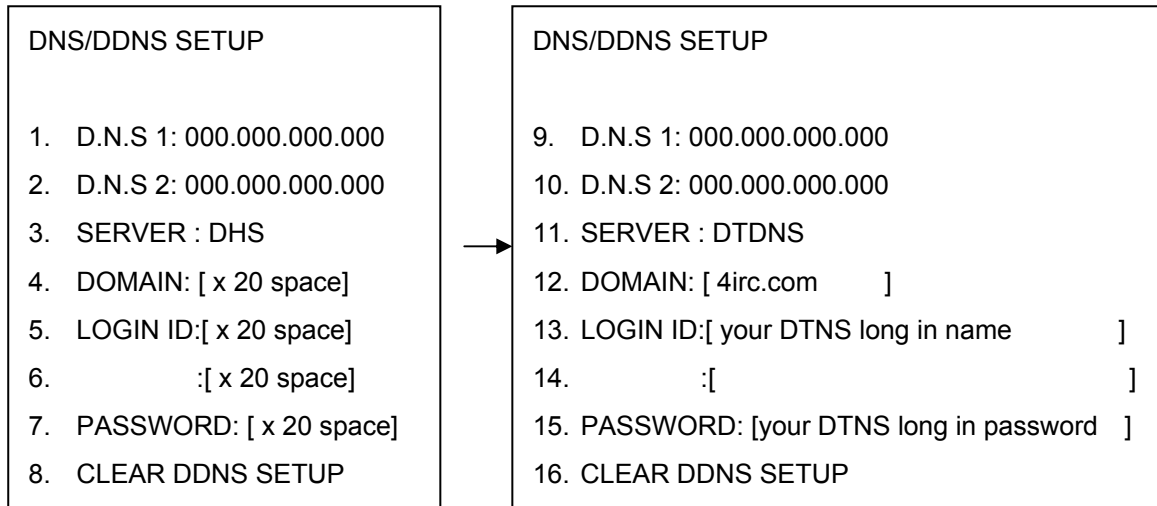

### **Important:**

**LOGIN ID: This is your DTDNS apply login user name! Not Hostname!**

**PASSWORD: This is your DTDNS apply login password, not Activation Code!**

## 6. HDD FORMAT

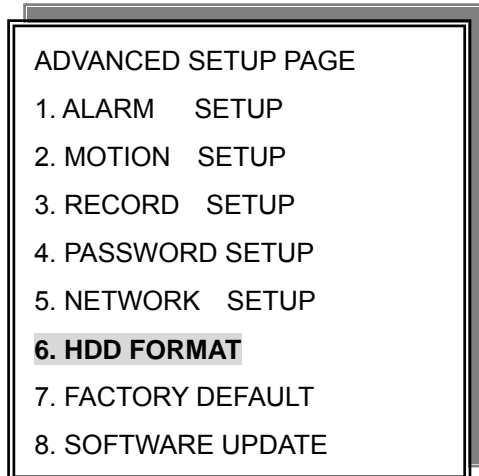

Press direction buttons up/down to  
HDD FORMAT items position.  
Press ENTER to format all HDD.

Caution: User can format HDD only when  
all HDD stop record or playback.

→ HDD FORMAT CAUTION!! :

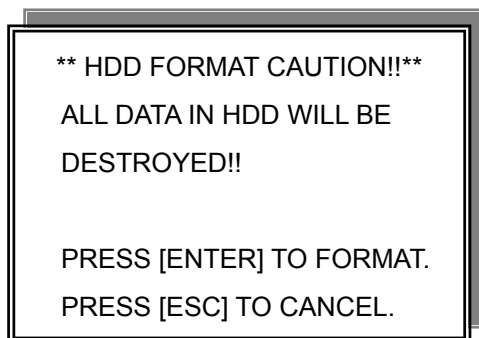

Press ENTER button to format hard disk.



Press ESC button to cancel hard disk format.

### Notice:

New hard disk detect: When DVR power, system would detect new hard disk install. If the hard disk is in different format, then the message popup. User needs to press ENTER to format, if press MENU, and then this hard disk would not be detected.

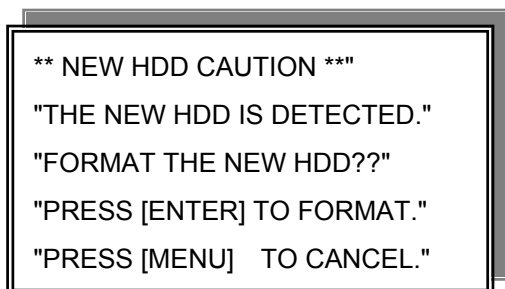

Press FORMAT to format.  
Press MENU to exit.

## 7. FACTORY DEFAULT

ADVANCED SETUP PAGE  
1. ALARM SETUP  
2. MOTION SETUP  
3. RECORD SETUP  
4. PASSWORD SETUP  
5. NETWORK SETUP  
6. HDD FORMAT  
**7. FACTORY DEFAULT**  
8. SOFTWARE UPDATE



Press direction buttons up/down to FACTORY DEFAULT items position.  
Press ENTER to restore.

**\*\* CAUTION!! \*\***  
ALL SETUP VALUE WILL BE CLEAR,  
AND RESTORE FACTORY DEFAULT!!  
  
PRESS [ENTER] TO RESTORE.  
PRESS [ESC] TO CANCEL.



Press ENTER button to restore.



Press ESC button to cancel.

## 8. SOFTWARE UPDATE

ADVANCED SETUP PAGE  
1. ALARM SETUP  
2. MOTION SETUP  
3. RECORD SETUP  
4. PASSWORD SETUP  
5. NETWORK SETUP  
6. HDD FORMAT  
7. FACTORY DEFAULT  
**8. SOFTWARE UPDATE**

SOFTWARE UPDATE  
UPDATE METHOD:  
  
START UPDATE

UPDATE METHOD: USB / HTTP / UNIX

USB: Copy firmware to USB device, and then plug in DVR USB interface. Choose START UPDATE and then press ENTER to start. Or save the update version to USB device, DVR system would do data update automatically. USB ERROR displays if no any USB device plug.

NETWORK: Press START UPDATE to link. 80 Port must open in your network server.

UNIX: For R&D testing.

## USB Data Read and Networking

1. Windows 2000 / XP, select small character display.
2. Resolution 1024 x 768.
3. RAM up to 128 MB, system up to PIII-800.
4. Double click SETUP.EXE of CD, and then start to install.
5. User can go to company server to download AP software.

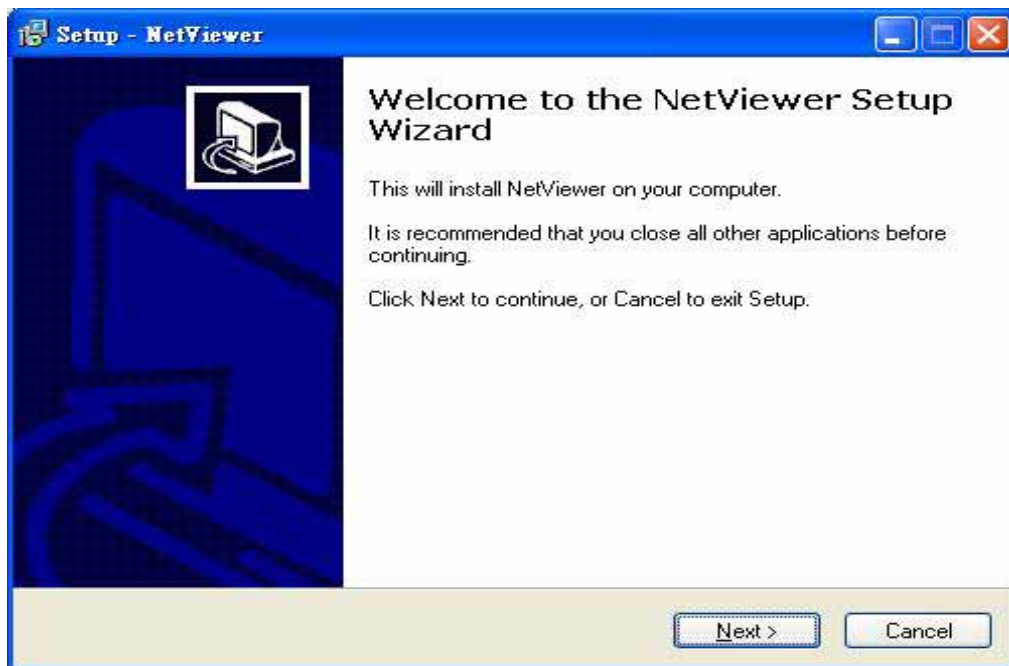

6. Browse install path and then click Next.

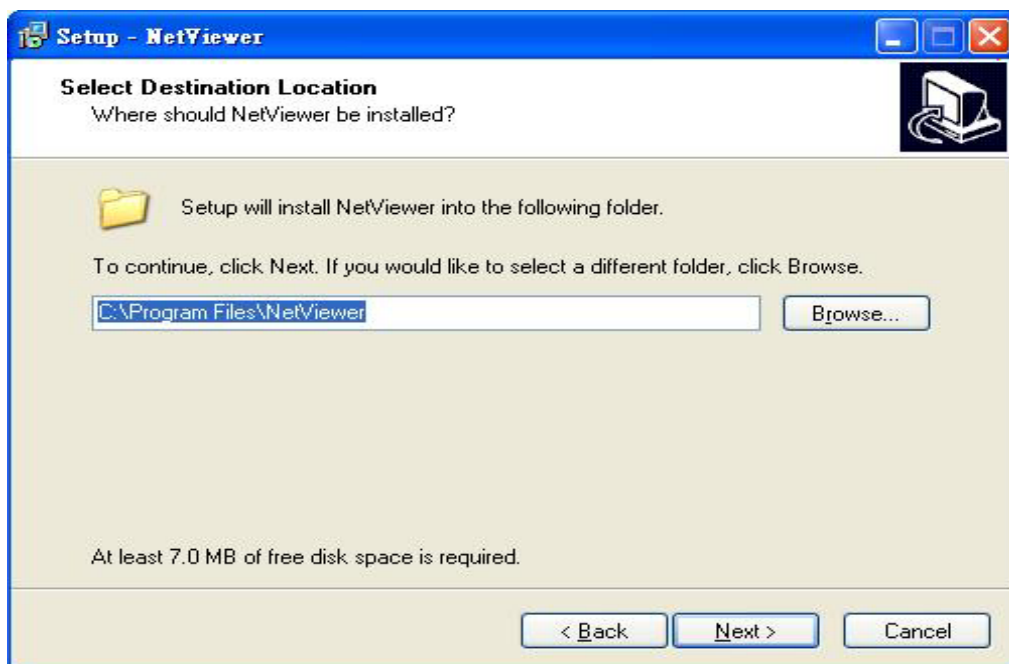

7. Advice resolution 1024 x 768. According computer equipment, please choose suitable resolution

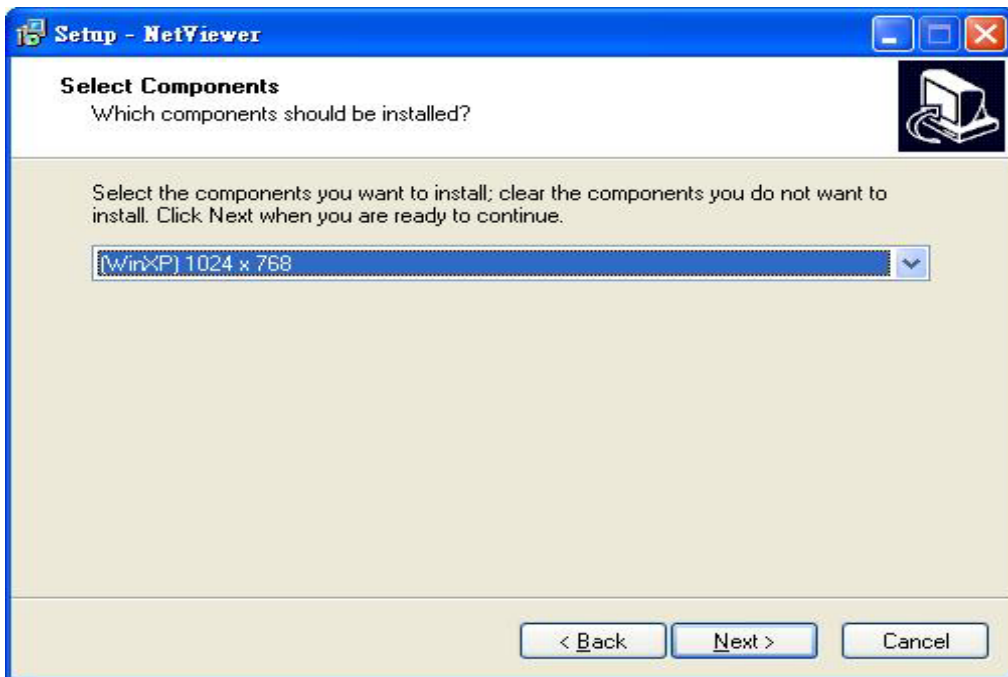

8. Select Start Menu Folder, and then click Next.

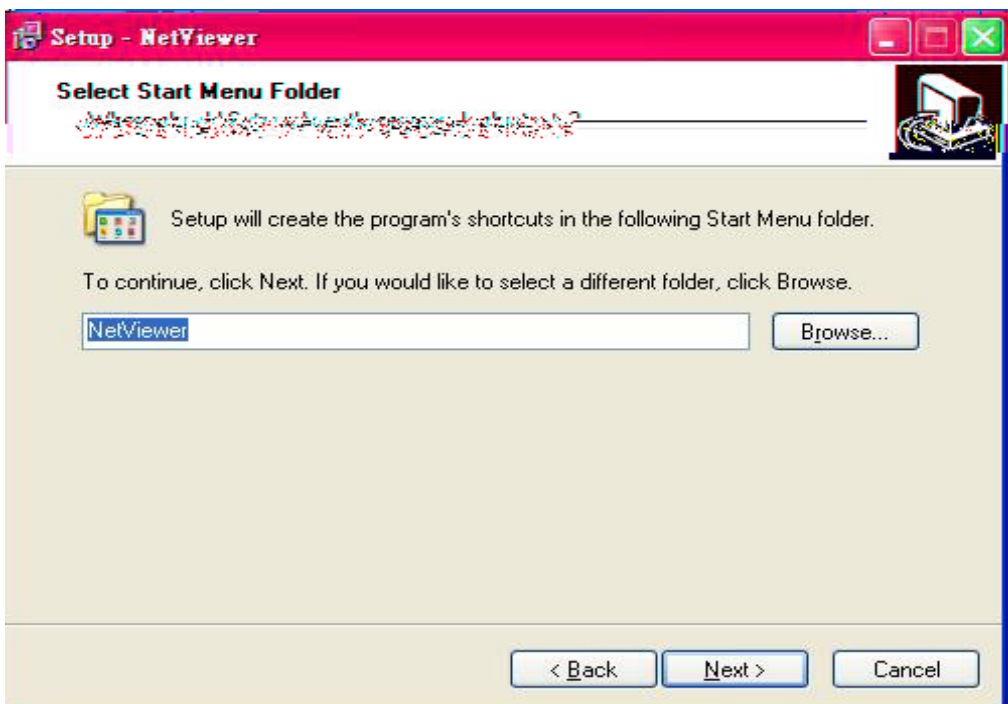



9. Click create a desktop icon or not, select DVR type, and then click Next.

4 CH and 16 CH DVR Net viewer is suitable. Only some split screen can not display.

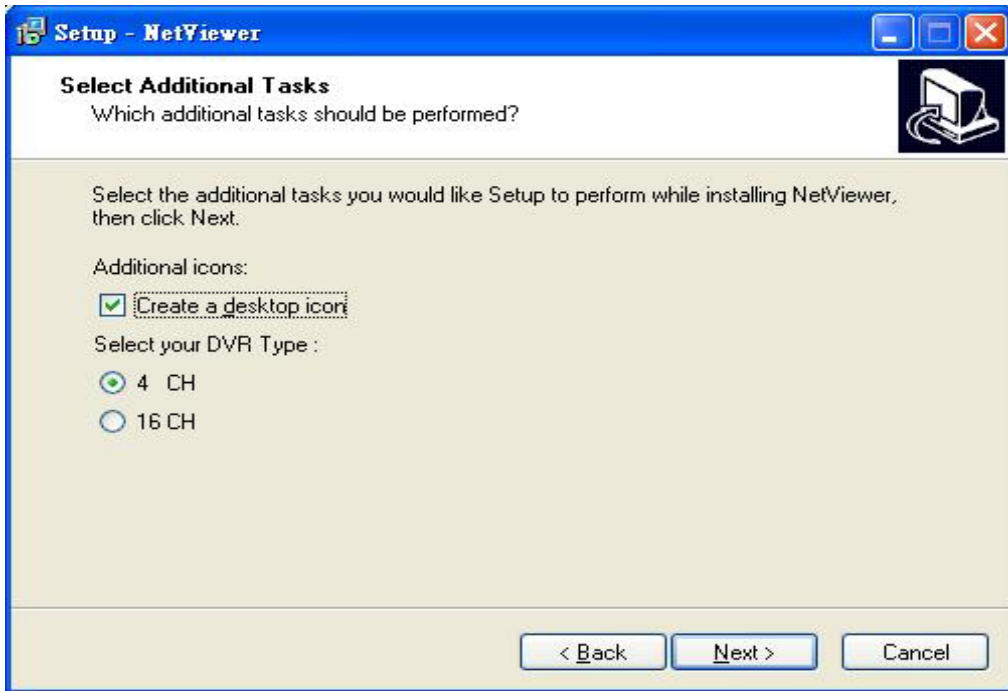

10. Click INSTALL to start install.

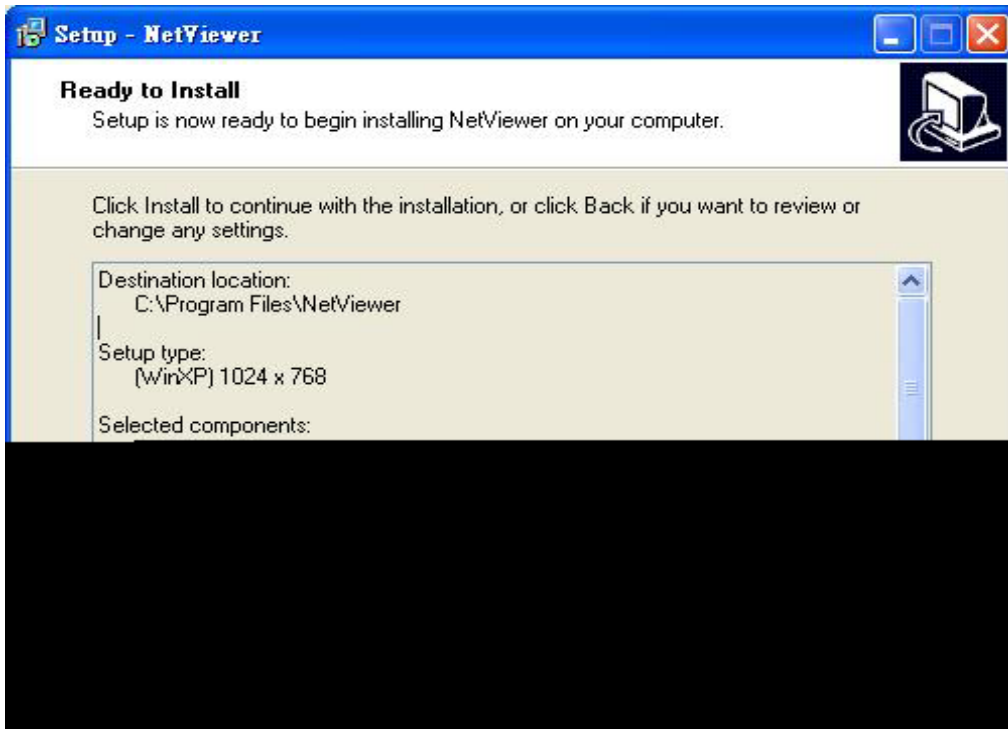

11. Click Launch NetViewer and click Finish to done.

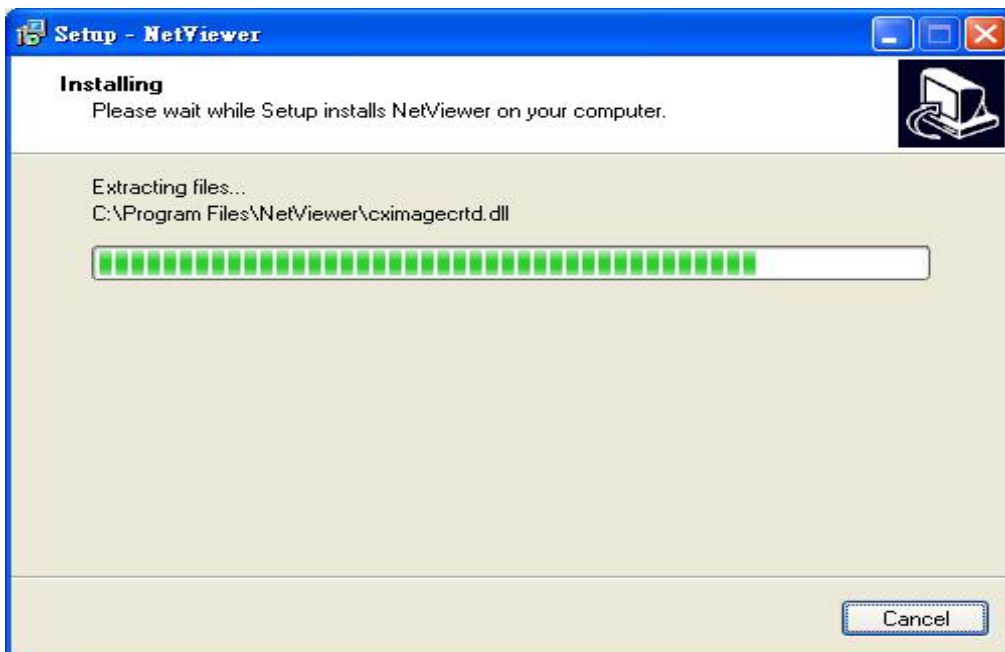

**12. Click Setting.**

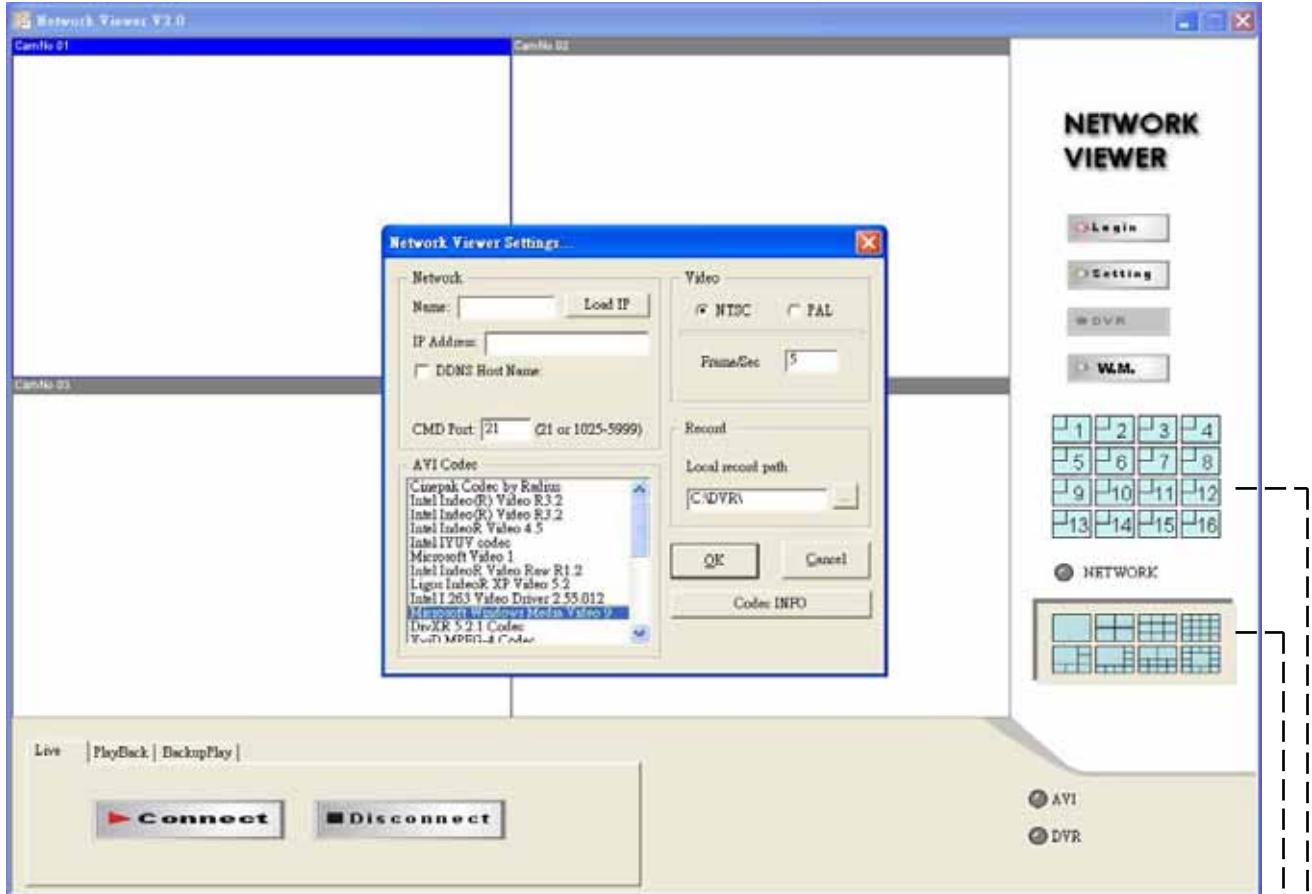

**Name:** Name the IP address position.(Each name and IP saves every different input)

**IP Addr:** Input DVR IP address.

**AVI codec:** Different computer equipment; different AVI format.  
 Microsoft Windows Media video 9 is better.  
 Or Cinepak Codec by Radius(Slow transmission, better quality) /  
 Microsoft Video 1(Fast transmission, bad quality).

**Video:** Fullsize, Halfsize: screen size choose.

**NTSC, PAL. Frame/Sec:** Video system choose. Record frame choose.

**Click OK to confirm.**

On Live / PlayBack , click DVR to save action pictures, \*.DVR file. It needs this software to play.  
 Browser, Local record path could change. The path user changes is for .DVR save, \*JPG file is always C:\DVR

**- Press DVR to start record .DVR file(DVR LED green on.), press again to stop.**

1 ~ 16 full screen select. ←  
 Full / Quad / 9 split / 16 split ←  
 6 split / 8 split / 10 split / 13 split ←

Click DDNS Host Name:

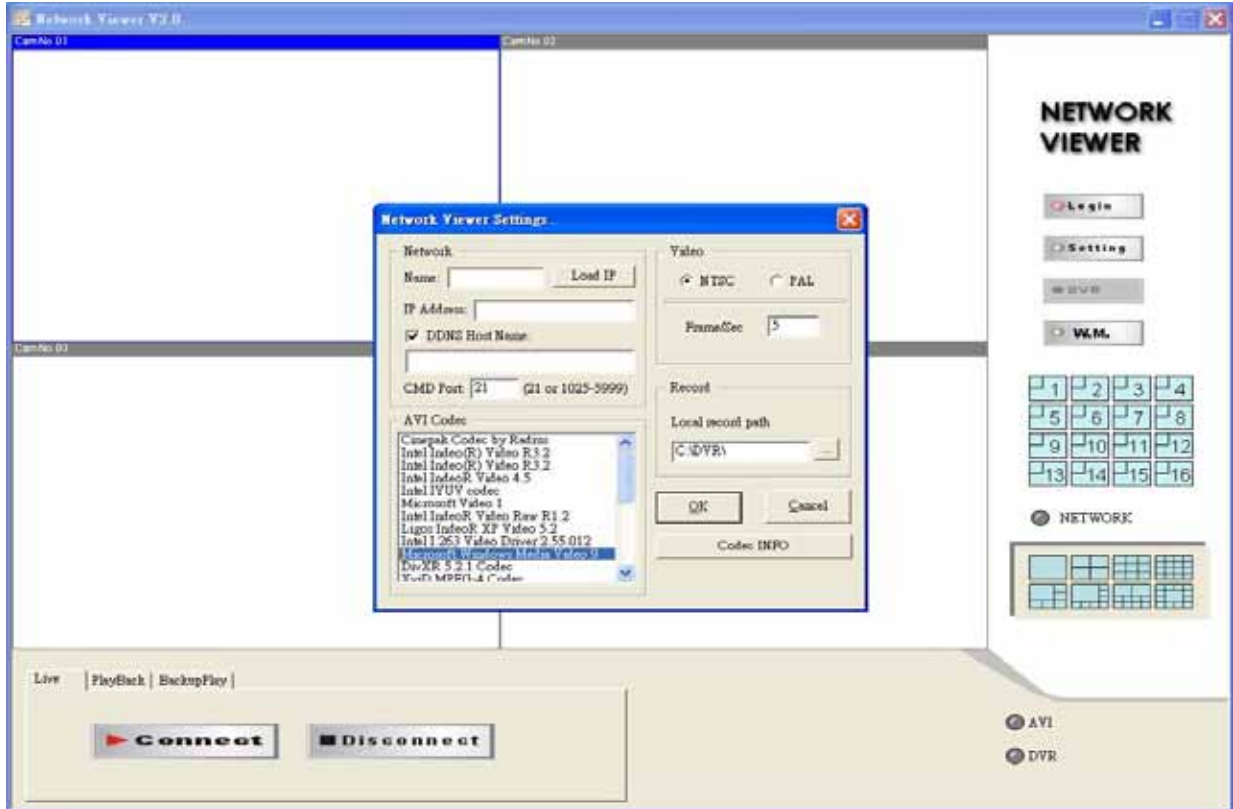

Type DVR DDNS host name: Myhostname.4irc.com  
 CMD Port: command port 21 or 1025 ~ 5999.  
 It is same as DVR network setup.

Which is same DVR MENU → ADVANCED SETUP → NETWORK SETUP → DVR NAME:

- TCP-IP SETUP PAGE
- 1. SPEED:>512K
- 2. DVR NAME:[Myhostname ]
- 3. NET TYPE: OFF
- 4. STATIC IP SETUP
- 5. PPPOE ID SETUP
- 6. DNS/DDNS SETUP
- 7. SERVER PORT SETUP
- MAC ADDR: xx.xx.xx.xx.xx.xx

- DNS/DDNS SETUP
- 1. D.N.S 1: 000.000.000.000
- 2. D.N.S 2: 000.000.000.000
- 3. SERVER : DTDNS
- 4. DOMAIN: [ 4irc.com ]
- 5. LOGIN ID:[ your DTNS long in name ]
- 6. : [ ]
- 7. PASSWORD: [your DTNS long in password ]
- 8. CLEAR DDNS SETUP

DDNS host name:  
 Myhostname.4irc.com

13. Click Login, depends on limits of authority. (ID / password is same as DVR)

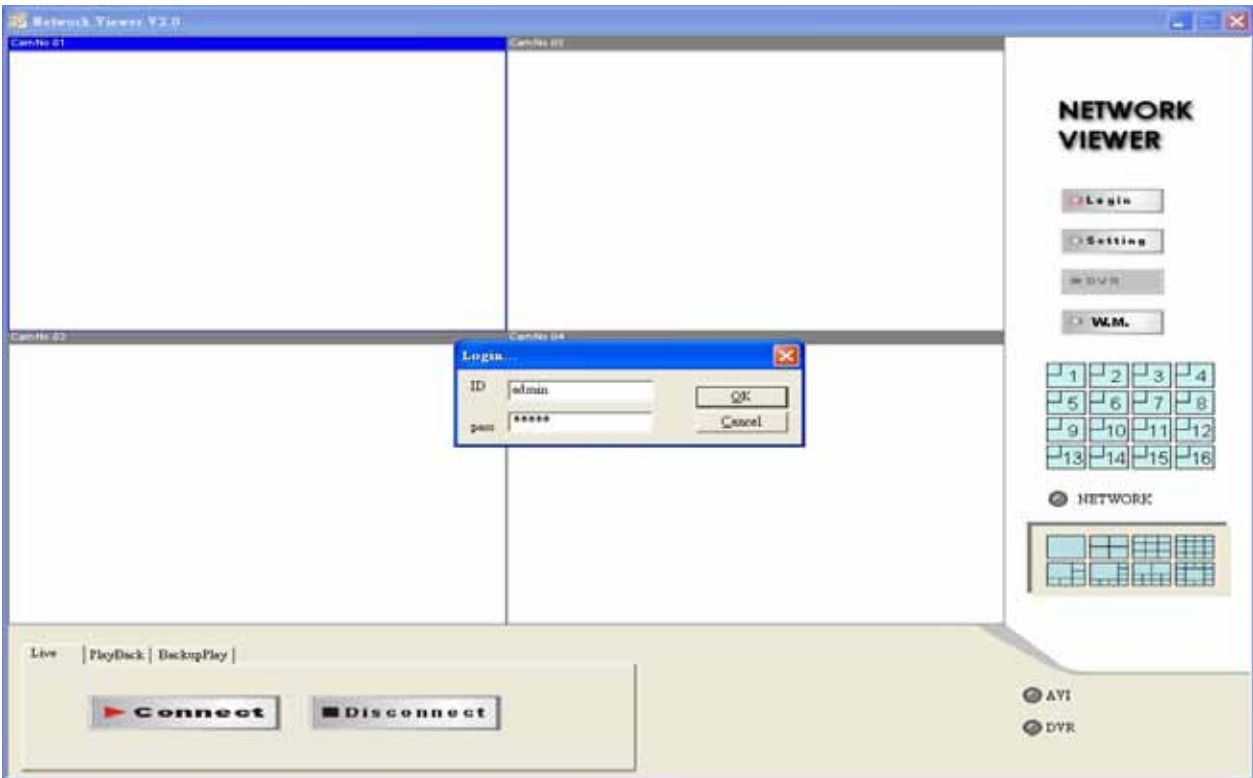

Factory ID is user login. Input admin if you are an administrator. Must input on little character.

Factory: Password, admin : 44444, user : 11111. Password displays when log in, user just needs to input ID.

User log in, no PlayBack function authority. Total 6 people log in. Admin x 1, user x 5.

Click OK, after about 5 seconds, admin login!! Message popup. And then click Connect to start.

Login OK!! Check ID or PASSWORD is correct.



Login error!! Check ID or PASSWORD is correct.



14. Click Connect, after about 2 ~ 3 seconds to start connect LAN or WAN. Click Disconnect to stop. If the NETWORK is connecting success, the blue light would keep glisten



Click live / PlayBack / BackPlay mode.

Live: DVR live watching.

PlayBack: Change to playback mode. After 2 ~3 seconds to change.

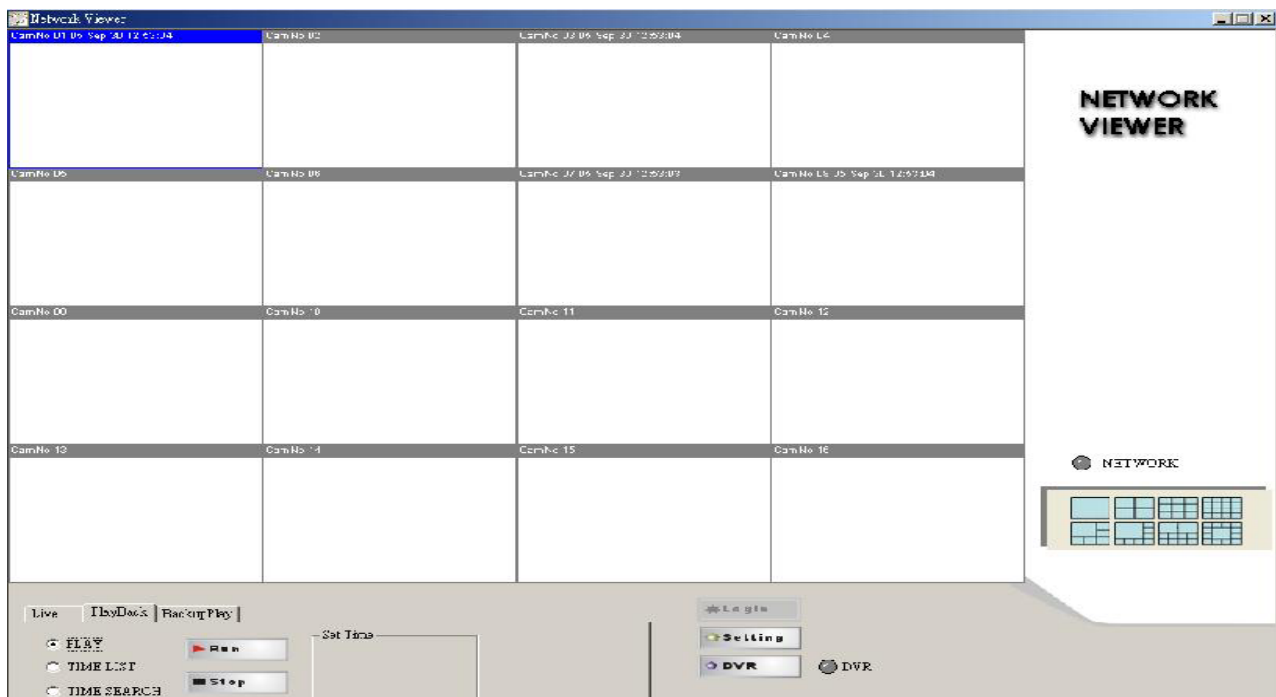

PLAY: Click RUN around 2 ~ 30 seconds to start play first record. If over 30 seconds, cannot find any file or network disconnect, Time out message popup. Please try again play or connect again. Click STOP to end playback.

TIME LIST: Click RUN, time lists popup. On the item, double click date and time to start play, around 2 ~ 30 to start play first record. If over 30 seconds, cannot find any file or network disconnect, Time out message popup. Please try again play or connect again. Click STOP to end playback.

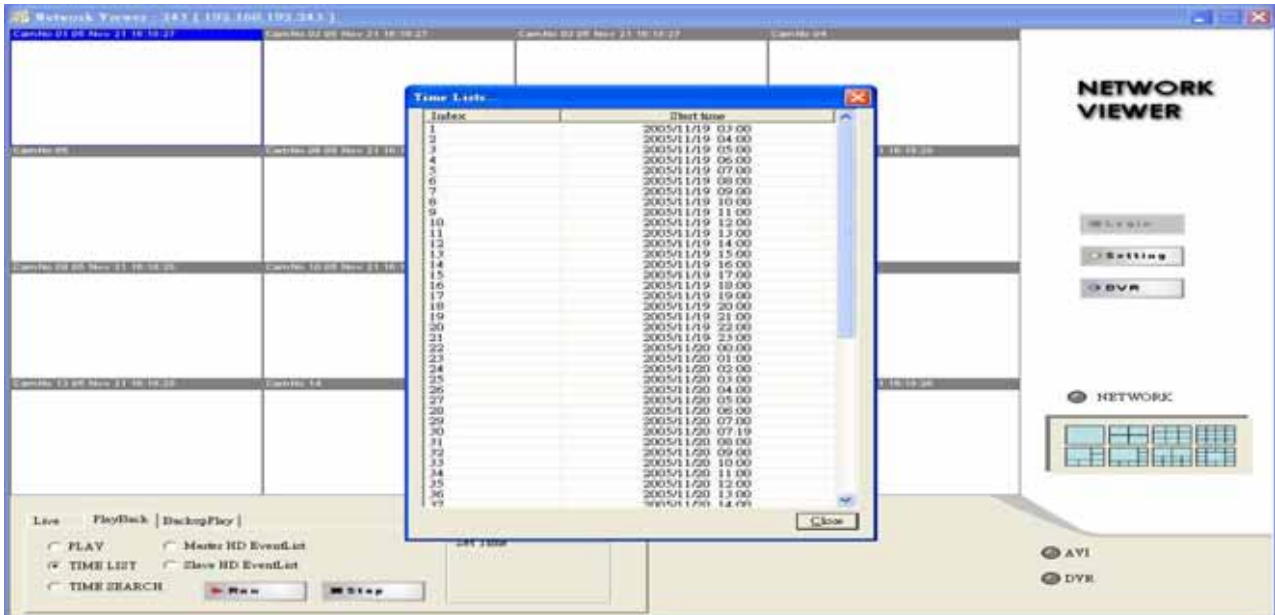

TIME SEARCH: Chose date and time, click RUN, around 2 ~ 30 seconds to start play first record. If over 30 seconds, cannot find any file or network disconnect, Time out message popup. Please try again play or connect again. Click STOP to end playback.

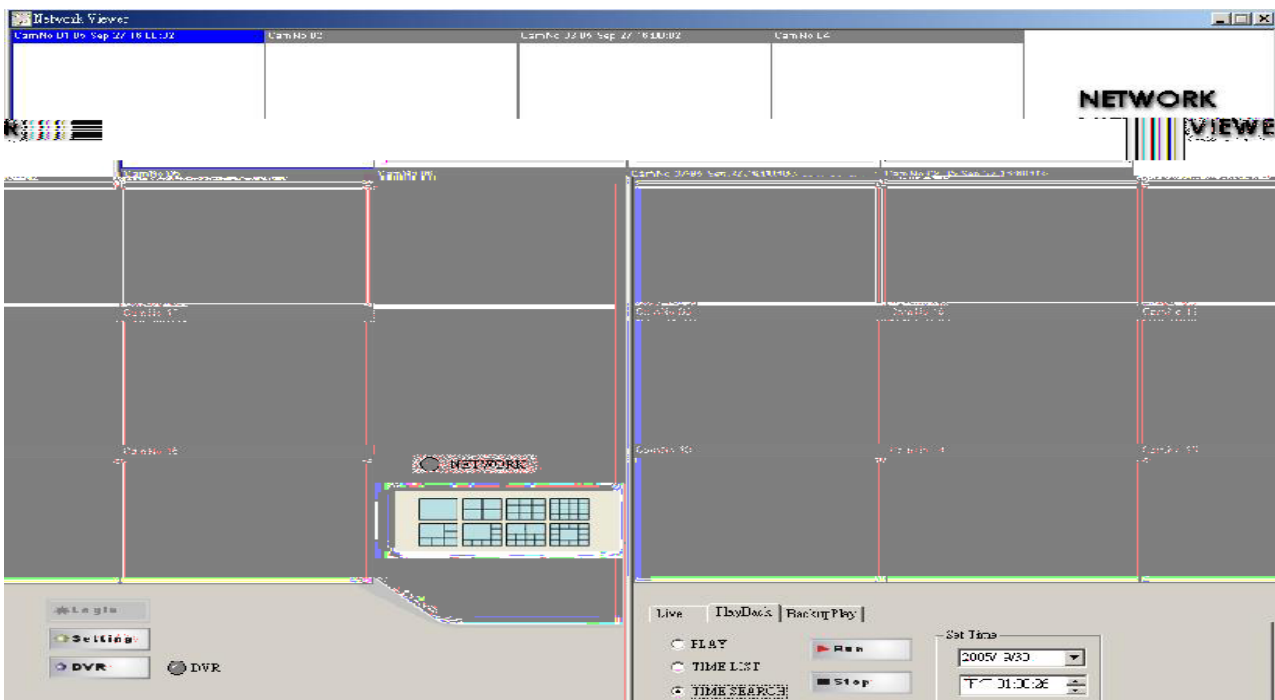

Notice: PLAY / TIME LIST / TIME SEARCH change, needs to stop play first.

**-Master HDD Event Lists:**

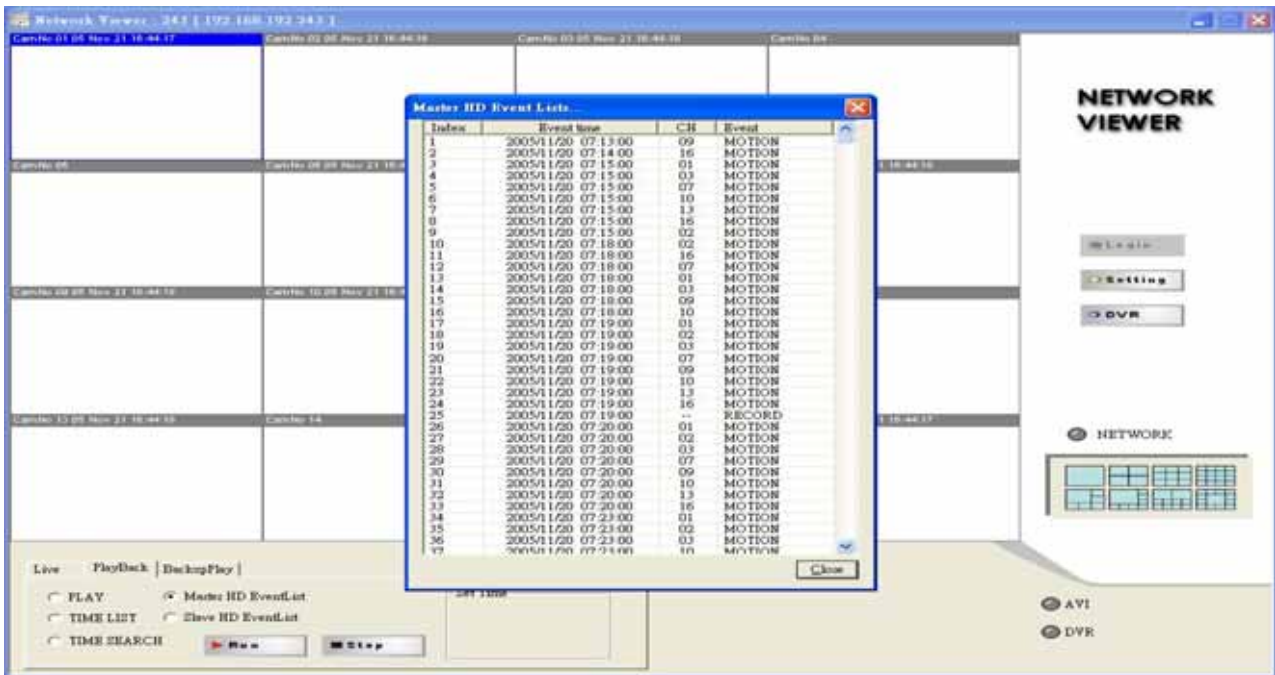

**-Slave HDD Event Lists:**

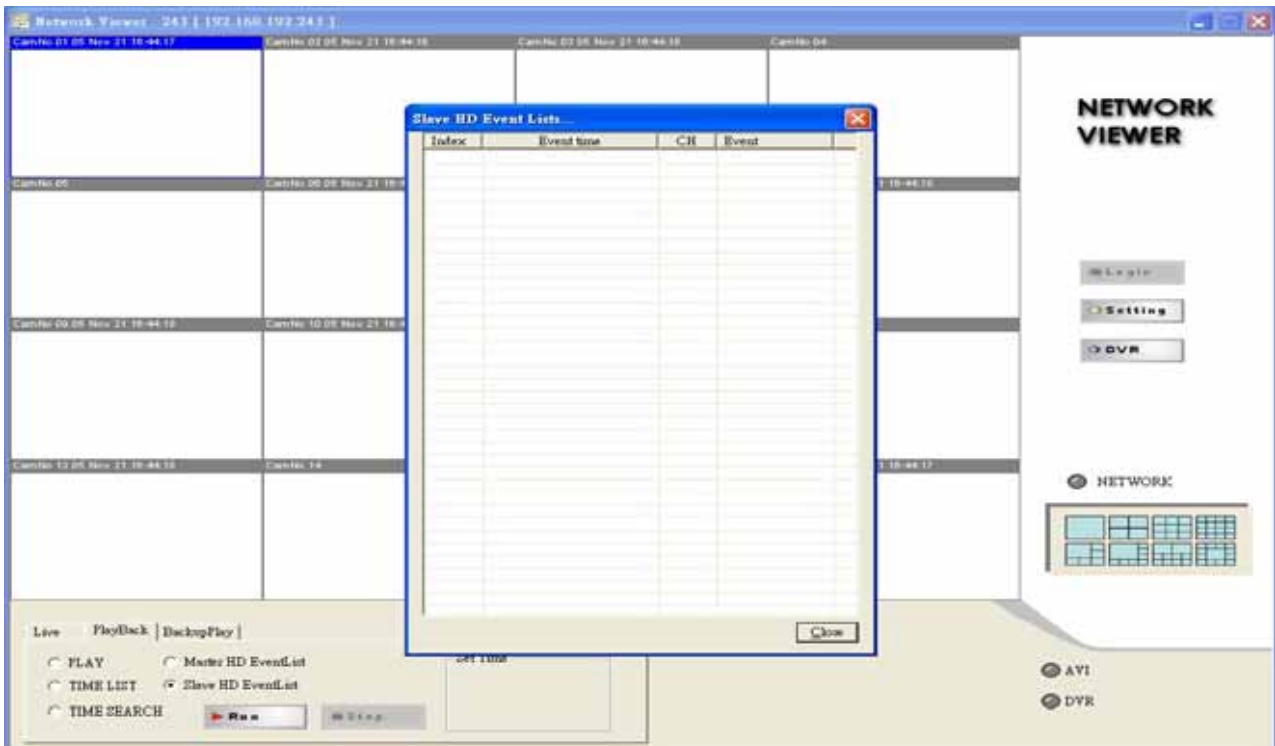

Click RUN, time lists popup. On the item, double click date and time to start play, around 2 ~ 30 to start play first record. If over 30 seconds, cannot find any file or network disconnect, Time out message popup. Please try again play or connect again. Click STOP to end playback.



## 15. Backup Play:

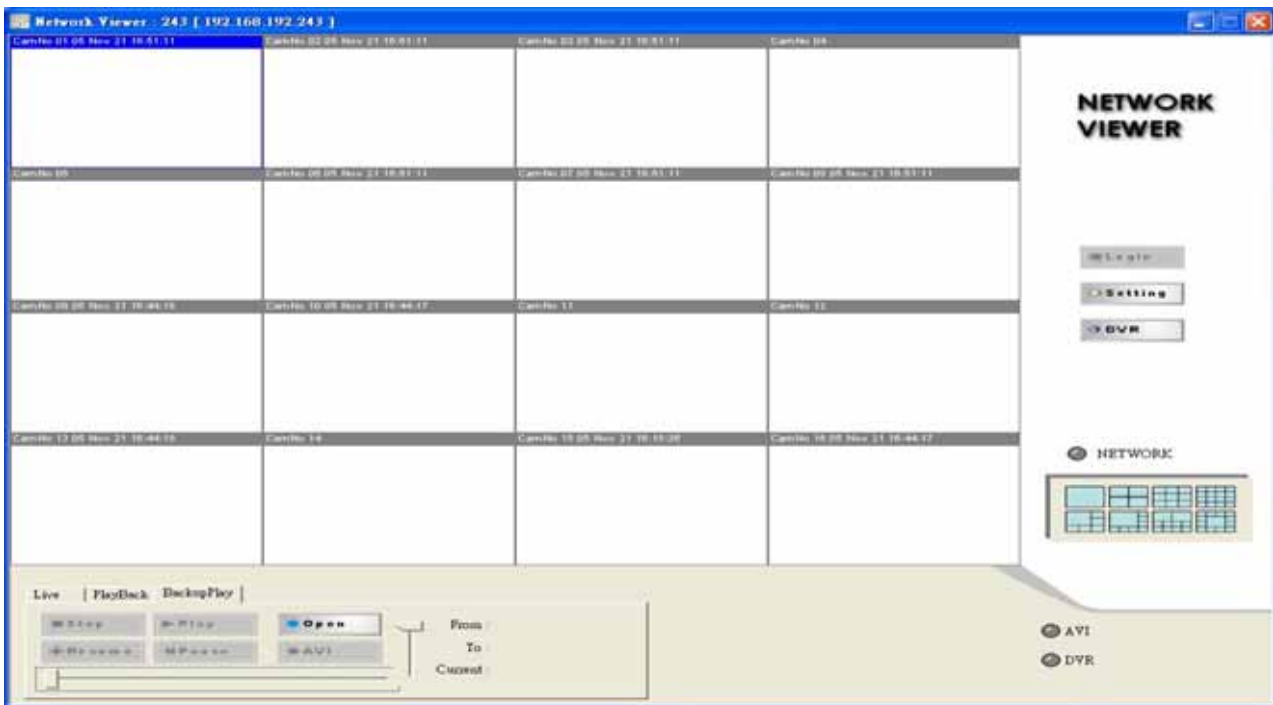

- Click Open to choose file path.

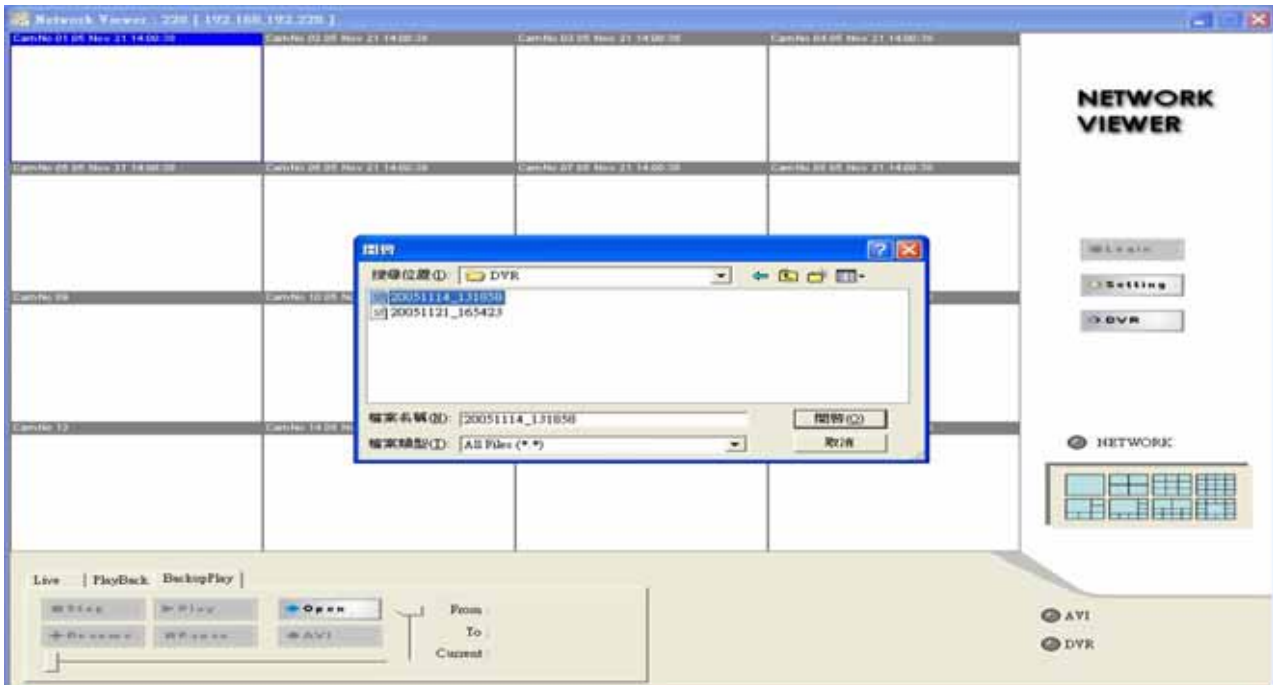

Click Play to start backup data play. Click Stop to end. Click Pause to temporary stop playback. Click Resume to restart.



Choose camera, click mouse right button. Camera 1 ~ 4 switches or reset all. Click Save "CamNo xx image . / save image all to save current image. Save path is C:\DVR.

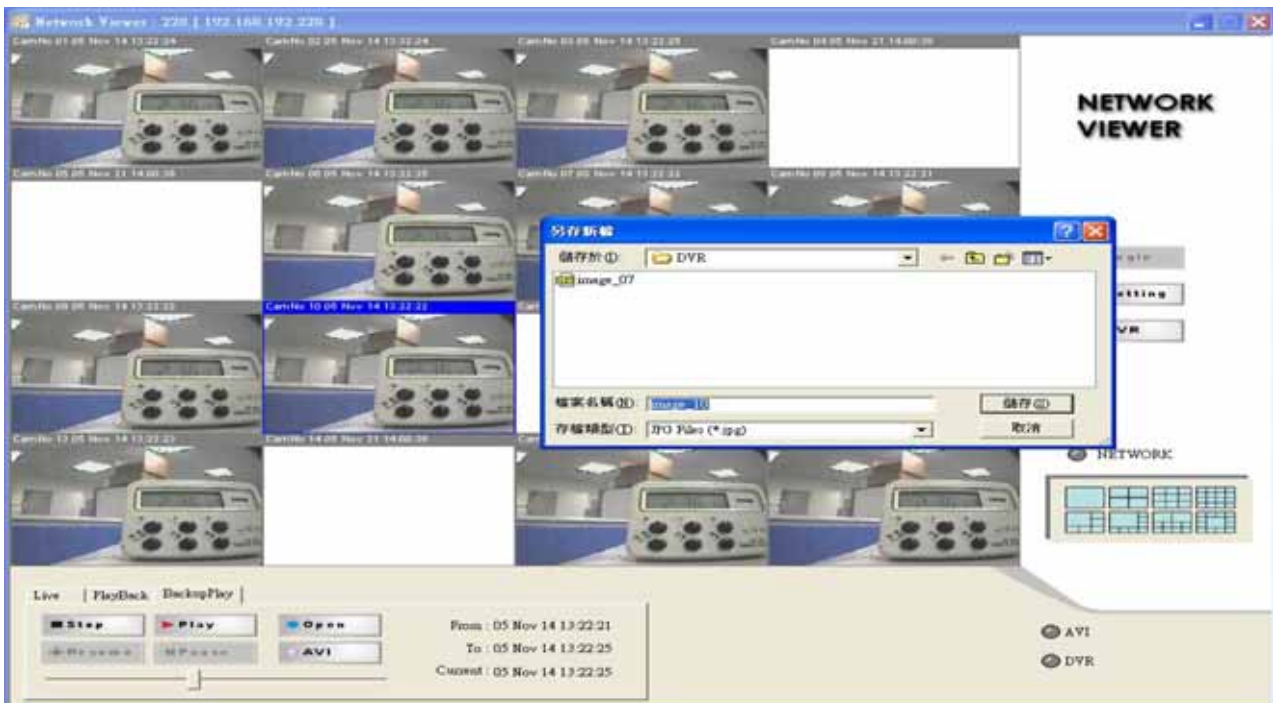

#### 4. AVI transfer: Click Backup Play

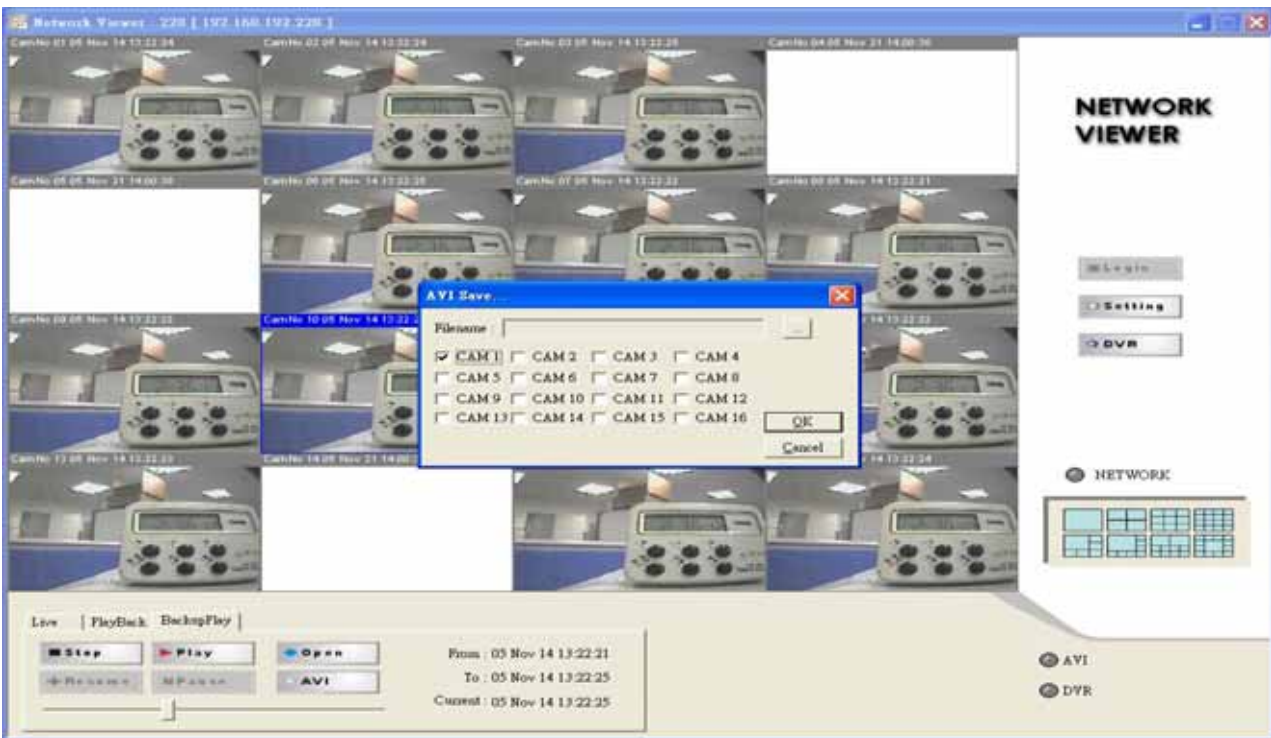

**AVI** : On live or playback mode, save files to .DVR file. And then OPEN file, press play to start playback. Press AVI button to start record AVI file. Press again to stop.

Only 2 cameras selectable. A warning message appears if user selects over 3 cameras,

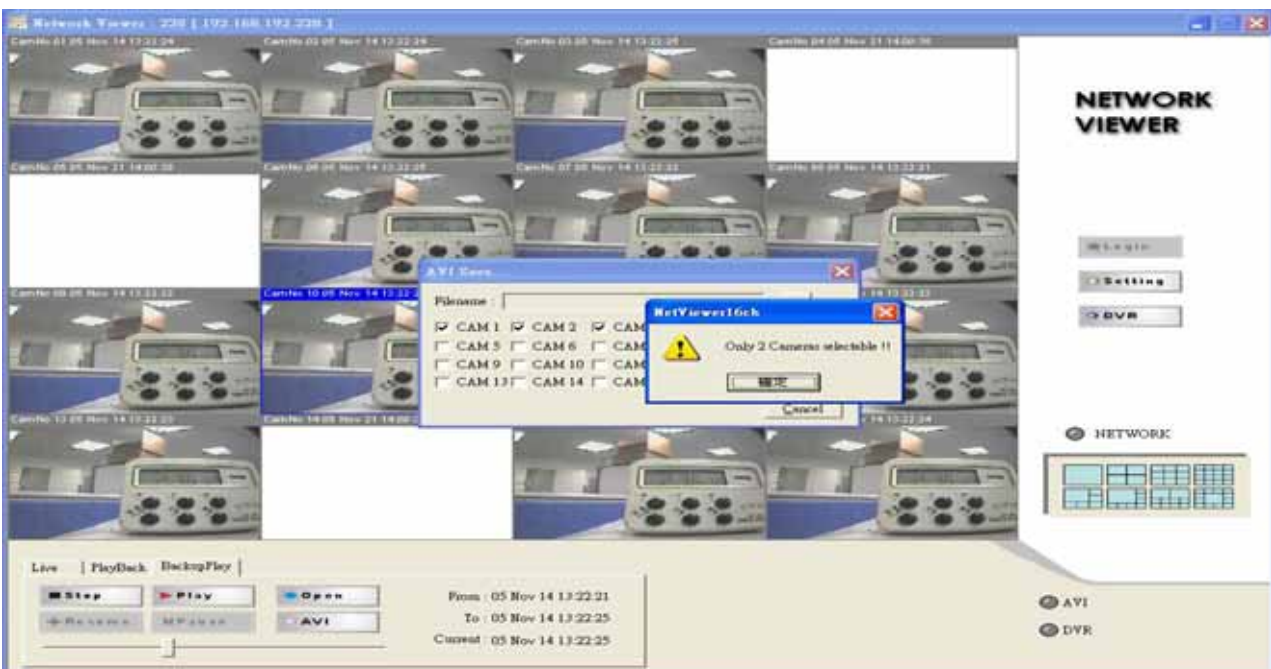

## Record Time Table: 80GB HD

**Record Quality:** Low. KB Range: Lowest: 13, Highest: 20. Average: 17.

REC FPS	120	60	30	15	10
REC Hour	11	22	45	91	137
REC FPS	5	3	2	1	1/2
REC Hour	274	456	685	1370	2741
REC FPS	1/3	1/5	1/10	1/15	1/30
REC Hour	4112	6853	13706	20565	41140

**Record Quality:** Normal. KB Range: Lowest: 14, Highest: 25. Average: 20.

REC FPS	120	60	30	15	10
REC Hour	9	19	38	77	14
REC FPS	5	3	2	1	1/2
REC Hour	233	388	582	145	2330
REC FPS	1/3	1/5	1/10	1/15	1/30
REC Hour	3495	5825	1450	17479	34967

**Record Quality:** Fine. KB Range: Lowest: 15, Highest: 28. Average: 22.

REC FPS	120	60	30	15	10
REC Hour	8	17	35	70	105
REC FPS	5	3	2	1	1/2
REC Hour	211	353	529	1059	2118
REC FPS	1/3	1/5	1/10	1/15	1/30
REC Hour	3177	5295	10591	15890	31787

**Record Quality:** High. KB Range: Lowest: 17, Highest: 30. Average: 24.

REC FPS	120	60	30	15	10
REC Hour	7	4	32	64	97
REC FPS	5	3	2	1	1/2
REC Hour	194	323	485	970	1941
REC FPS	1/3	1/5	1/10	1/15	1/30
REC Hour	2912	4854	9709	14563	29127

**Record Quality:** Super. KB Range: Lowest: 19, Highest: 45. Average: 32.

REC FPS	120	60	30	15	10
REC Hour	6	12	24	48	72
REC FPS	5	3	2	1	1/2
REC Hour	145	242	364	728	1456
REC FPS	1/3	1/5	1/10	1/15	1/30
REC Hour	2184	3640	7281	10922	21845

Actual recording time is base on live environment. This table only for reference.

## VGA Description (Optional)

Accessories:

1. 20 PIN Male to Female D-SUB pin cable X 1
2. VGA PCB bracket X1
3. Screws X4

1. VGA board introduction.

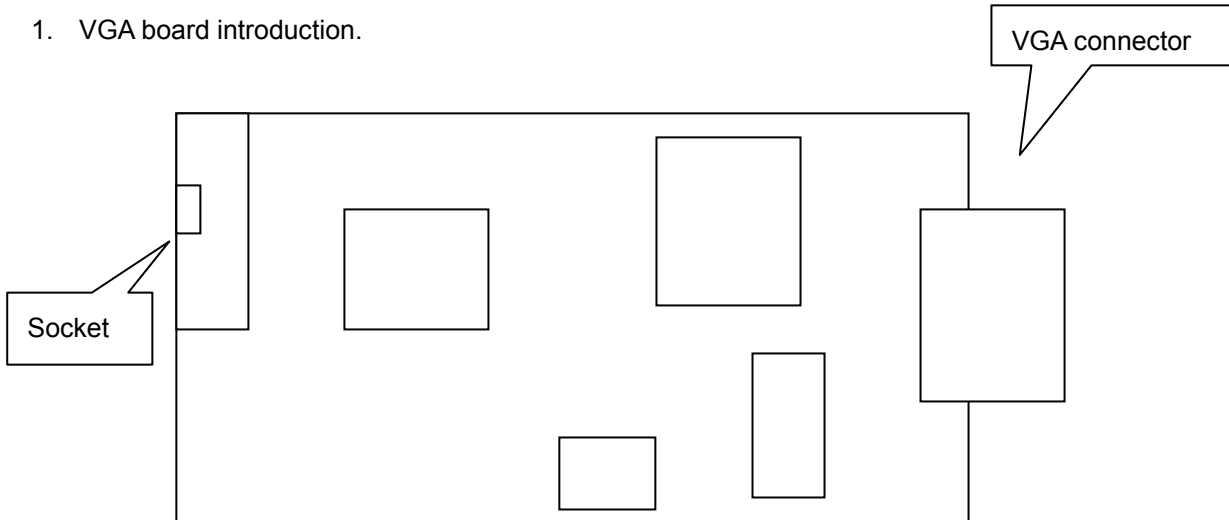

2. Resolution switcher table

Pin 4	Resolution	Pin 1	Pin 2	Pin 3
	640X480 60HZ	ON	ON	ON
	800X600 60HZ	ON	ON	OFF
	1024X768 60HZ	ON	OFF	ON
	640X480 75HZ	ON	OFF	OFF
	800X600 75HZ	OFF	ON	ON
	1024X768 75HZ	OFF	ON	OFF

Resolution and switcher description.

Step. 1	DVR Power on. NTSC / PAL auto detects.
Step. 2	Pin 4 no used
Step. 3	Pin 1 ~ 3 switcher resolution. Do not need to power off DVR.

## Additional

Hard Disk x 2 can be installed on DVR base. Both are 2-iron slices immobile type.  
2 Iron slices are in the accessories box, please tell supplier if slices are not exist

2-iron slices immobile type:

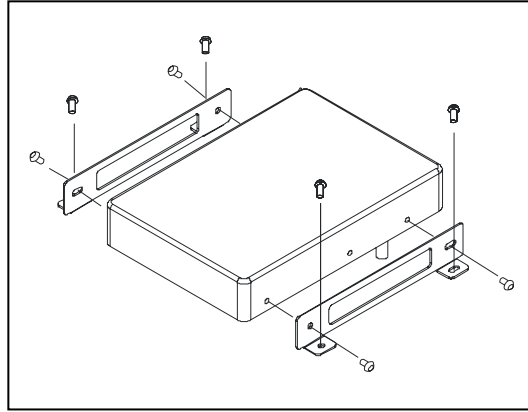
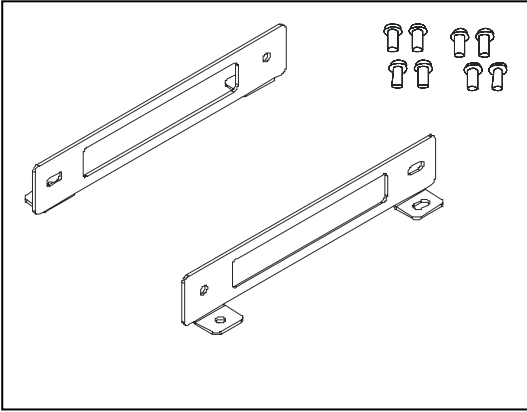

Slices immobile type: 4 screws hole on each slice. 2 for DVR base fixed. Another 2 for hard disk fixed.

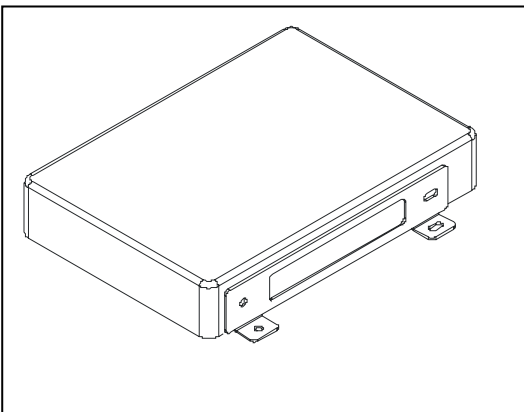

Hard disk install.: Locking hard disk screws, then locking DVR base screws to fixed on.

## P / T / Z Dome mode.

### 6. ADVANCED SETUP PAGE → P.T.Z SETUP

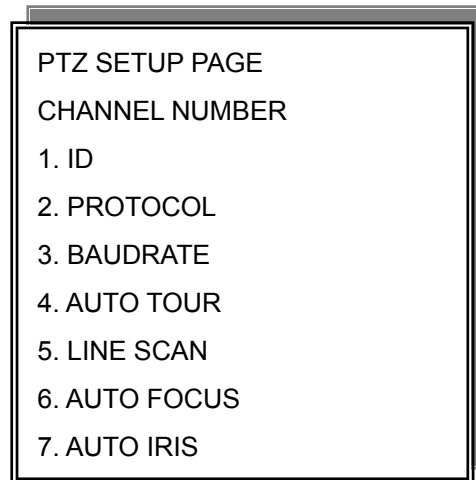
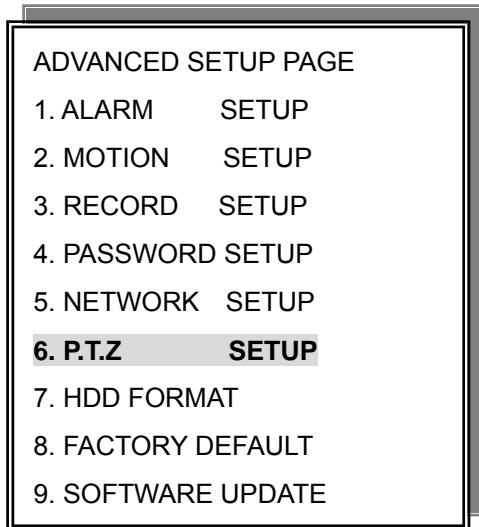

#### PTZ SETUP PAGE

CHANNEL NUMBER: CH01 ~ CH4

1. ID: 01 ~ 4

2. PROTOCOL: PELCO-P / PELCO-D / LILIN / ABC / ELITAR / DENTEC-D / DENTEC-P / OFF

3. BAUDRATE: 1200 / 2400 / 4800 / 9600

4. AUTO TOUR: ON / OFF

5. LINE SCAN: ON / OFF

6. AUTO FOCUS: ON / OFF

7. AUTO IRIS: ON / OFF

After PTZ setup done, go back to live mode. Press W.M. button to PTZ mode.



Icon displays beside date and time caption. To use direction button left/right/up/down

to move PTZ Dome. PTZ Dome can not be control on split screen.

PS. Because the P / T / Z Dome setup is independent by channel and ID, user does not worry about the different ID / Protocol / Baud Rate would affect DVR controls P / T / Z dome error. Just make sure channel and ID / Protocol / Baud Rate corresponding is correct.

### **Front Panel Button Comparison:**

W.M.: To P / T / Z mode

PLAY / REC = IRIS off / IRIS open

◀ ▶ = FOCUS near / FOCUS far

BACKUP / T-SRH = ZOOM IN / ZOOM OUT

MENU = P / T / Z Dome Menu

FRE. : To Preset mode. PRESET: 000 glisten on left-up corner. Moves P / T / Z dome to the position user wants.

When "PRESET: glistening", press number button.

EX: 1 ~ 9. 10 = 1 + 10, 11 = 1 + 1, 12 = 1 + 2, 21 = 2 + 1, 132 = 1 + 3 + 2.

ZOOM : After press ZOOM button to save the presets.

INFO : Press FRE. button into preset mode. When "PRESET: glistening", press number button, and then press INFO to call preset.

AUTO : Press FRE. button into preset mode. When "PRESET: glistening", press number button, and then press AUTO to clear preset.



## IE Networking Software

1. This web is for preliminary IE browser.
2. User can download the network viewer from this web page or view the DVR video image in the future.
3. The AP software is already saved to DVR system IC. User needs to do is:
  - a.) Go to Advanced Setup→ Network Setup→Sets LAN or WAN IP address of DVR.
  - b.) Open IE browser, and then into your IP on the IE address bar.
  - c.) If LAN or WAN connects ok, the 4 Channel Digital Video Recorder web page displays like under:

